



ECDIS (Electronic Chart Display and Information System)

◆ HM-5818(19" 24" 26")

User Manual

User Instructions:

Copyright.

Unless hereby stated, no part of this manual can be reproduced, printed, copied, sent, disseminated, downloaded or stored on any media without prior written authorization of **Xinuo Information Technology (Xiamen) Corporation Limited**. As permitted by Xinuo Information Technology (Xiamen) Corporation Limited, simplified copies of this manual can be downloaded to hard disks or other electronic media for browsing, or this manual and its revisions can be printed. The ownership of copyright shall be specified in all reproductions. This manual or any of its revisions is prohibited from being used for commercial purposes.

This manual is subject to change without notice. You can get the updates and the information on how to use or operate this product and others from www.xinuo.com, the website of Xinuo Information Technology (Xiamen) Corporation Limited.

Warning: Please read the notes of this manual carefully to know about safety statements and other important information of products.

Declaration: All words like “XINUO” and “XINUO TECH” mentioned here below refer to as “Xinuo Information Technology (Xiamen) Corporation Limited”.

Note: This set of equipment shall not be directly used for navigation.

In practices, please use the equipment in combination with other navigation equipment and actual marine conditions such as paper chart, portable beacon, radar, tide, hydrological conditions and weather.

Declaration: Names of other products and companies mentioned in this user manual are only used for identification. They possibly belong to registered trademarks or copyrights of other companies.

Names and versions of software are just displayed on a display, but not described in this manual in detail.

Explanation of the mark used in this manual:

【 】: Titles of quoted menus. For example, 【Basic Menu】 is the basic menu called from a system.

Notes:

Before starting the vessel borne navigation equipment, be sure to read following notes carefully to avoid product failures arising from improper operation:

1. Please don't place the vessel borne navigation equipment at random without fastening, in order that the equipment won't be severely damaged when it falls off because of tossing or other factors during the navigation.
2. Please don't use any other power adapter which is not equipped for this product, or else the vessel borne navigation equipment would fail to work for differences in circuit design, or its performances would be affected, and the machine would be even damaged. The voltage of this machine must be AC 220V, and must not go beyond this range.
3. Please don't dismantle the vessel borne navigation equipment, or else you will be unable to enjoy the free warranty services if the vessel borne navigation equipment is dismantled by yourself instead of a maintenance engineer authorized by our company.
4. In operating or cleaning the vessel borne navigation equipment, avoid any liquid or other objects falling off inside the equipment, in order not to cause damages to circuit or a short circuit.
5. Please don't place the vessel borne navigation equipment and its accessories in damp areas or have them directly exposed to sun. The machines shall be operated under dry conditions.
6. The power supply shall be reliably grounded to avoid static electricity and lightning strike. If the instrument is not used for the time being, please switch the power supply off.
7. In case of over high external temperature, the vessel borne navigation equipment would crash. In this case, please shut down it for the time being, and restart it when it is restored to the normal temperature.
8. When LCD (Liquid Crystal Display) is used, it shall not be directly exposed to the sunshine, and its angle of elevation may be adjusted anytime for optimal visual effects.
9. In case of any hardware failure (e.g. burnt out power cord, damaged casing or foreign bodies falling inside the machine), please power the machine off and contact the distributor immediately.
10. Our company shall not be liable for any legal and other responsibilities arising from any marine accidents, financial or profit losses of vessel s equipped with out vessel borne navigation equipment.

Content

User Instructions:	1
Notes:	2
Content	3
Chapter 1	6
1.1 Product Descriptions	7
1.1.1 Hardware Components	7
1.1.2 Installation instructions	7
Chapter 2	18
2.1 Home Screen	19
2.1.1 Description of Operational Interface	19
2.1.2 Quick Operation Menu	21
2.2 Route design	25
2.2.1 New route	25
2.2.2 Editing waypoints	26
2.2.3 Deleting waypoints	26
2.2.4 Locking the route	26
2.2.5 Deleting a route	27
2.2.6 Display Settings	27
2.2.7 Route detection	27
2.2.8 Loading the route	28
2.2.9 Save the route	28
2.2.10 List of waypoints	29
2.2.11 Voyage schedule	30
2.2.12 Route Export/Import	32
2.2.13 Interaction Log	32
2.2.14 Settings	33
2.3 Route monitoring	34
2.4 Common waypoint	35
2.5 Electronic chart management	36
2.5.1 Chart unit	36
2.5.2 Unit License	37
2.5.3 Update log	37
2.5.4 Data Service Provider	38
2.6 Manual update	38
2.6.1 New object	39

2.6.2 Deleting objects	39
2.6.3 Moving objects	40
2.6.4 Correcting the object	40
2.6.5 Manually updates	41
2.7 Mariners' feature	41
2.8 Mariners' Note	42
2.9 Navigation record	43
2.10 AIS Information	44
2.10.1 AIS List	45
2.10.2 Messages	45
2.10.3 AIS navigation parameter settings	45
2.10.4 Target set	46
2.10.5 Display set	47
2.11 Radar target	47
2.12 ECDIS chart 1	48
2.13 Settings	49
2.13.1 OwnShip setting	49
2.13.2 System Settings	50
2.13.3 Chart setting	52
2.13.4 Sensor Settings	56
2.13.5 Alarm Settings	57
2.13.6 Network Settings	59
2. 14 Alarm	60
2.14.1 Overview	60
2.14.2 Alarm prompts and responses	61
2.14.3 Alarm Record	61
2. 15 LOP positioning	62
2.15.1 Overview	62
2.15.2 How to use	62
2.16 Distance and position calculation	64
2.16.1 Distance calculation	64
2.16.2 Position calculation	65
2.17 Standard Legend	65
Chapter 3	67
3.1 Summary	68
3.2 View Chart Information	68

3.3 Chart Sequencing	68
3.4 IHO S-63 Data Protection Solution	68
3.5 SA Certificate	69
3.5.1 Installation of SA Certificate	69
3.5.2 Uninstall SA Certificate	70
3.6 User permit	70
3.6.1 Generate User Permit	71
3.7 Data Service Providers	71
3.8 Cell permit	71
3.8.1 Install Cell Permit	72
3.8.2 Uninstall Cell Permit	73
3.9 Electronic Chart Cells	73
3.9.1 Install Exchange Set	74
3.9.2 Install Map (S-57 Electronic Chart)	77
3.10 Uninstall electronic chart	77
3.11 Update log	78
Chapter 4	79
4.1 Equipment maintenance	80
4.2 Operation Manual for HM-5818 Update Disk	81
4.2.1 Select boot device (If the default boot device is USB flash disk, you can skip this step)	81
4.2.2 Function Options	82
4.2.3 Update application	82
4.3 Operation manual for HM-5818 system rescue	83
4.3.1 Select boot device	83
4.3.2 Function Options	84
4.3.3 General Recovery	85
4.3.4 Advanced Options	86
Annex 1:Installation Dimension	87
Annex 2:Specifications and Standards	90
Annex 3:HM-5818 Specification	90

Chapter 1

Overview

In this chapter, an introduction is made to product appearances, accessories and keyboards.



1.1 Product Descriptions

HM-5818(19" 24" 26") Electronic Chart Display and Information System (ECDIS) is controlled by the host and composed according to structures of displays with different size, to make it convenient to install the system and meet the needs for different display size. Its software system is operated on an open platform known as Linux, designed with functional modules. Being stable and convenient for operation, it has a simple and clear human machine interface that can meet users' requirements.

1.1.1 Hardware Components

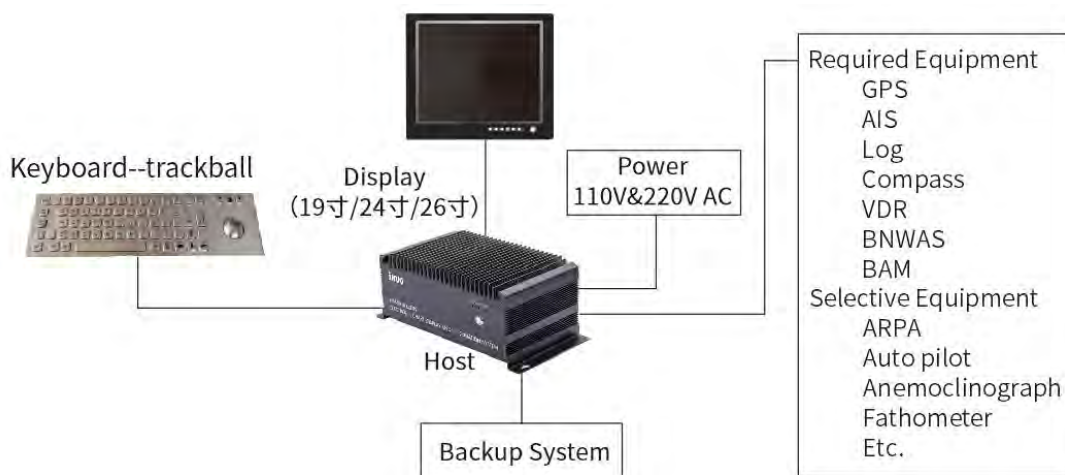



1.1.2 Installation instructions

Accessories list

No.	Name of item	Style	Quantity
1	Host		1
2	Display		1

3	keyboard--trackball		1
4	Audible and visual alarm		1
5	① Power cable (length: 3M)		2
6	② HDMI cable (length: 3M)		1
7	③ 7-pin to 2-pin (length: 2M)		1
8	④ Audio cable (length: 3M)		1
9	⑤ 5-pin cable (length: 1.2M)		1

10	⑥ USB cable (One end is a 5-pin air plug) (length: 2M)		1
11	⑦ Ethernet cable (length: 2M)		1
12	⑧ USB cable (length: 3M)		1

Connection diagram:

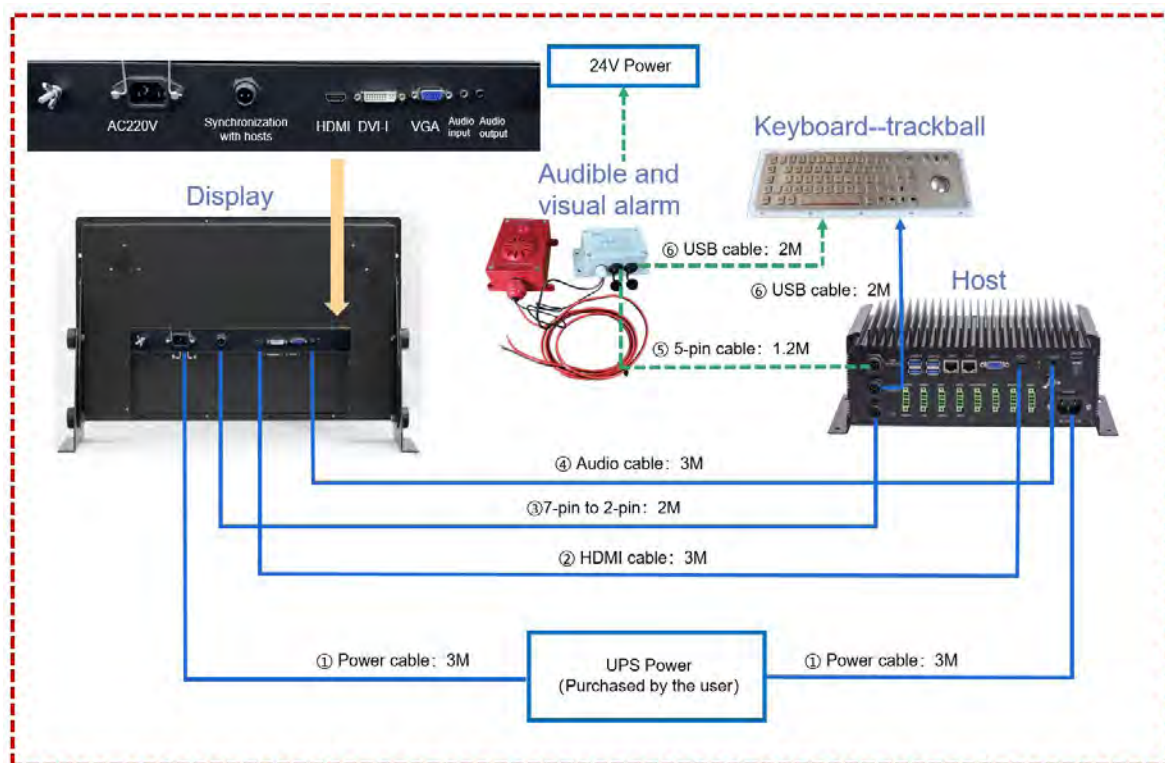

The connection principle diagram of Audible alarm is as follows :

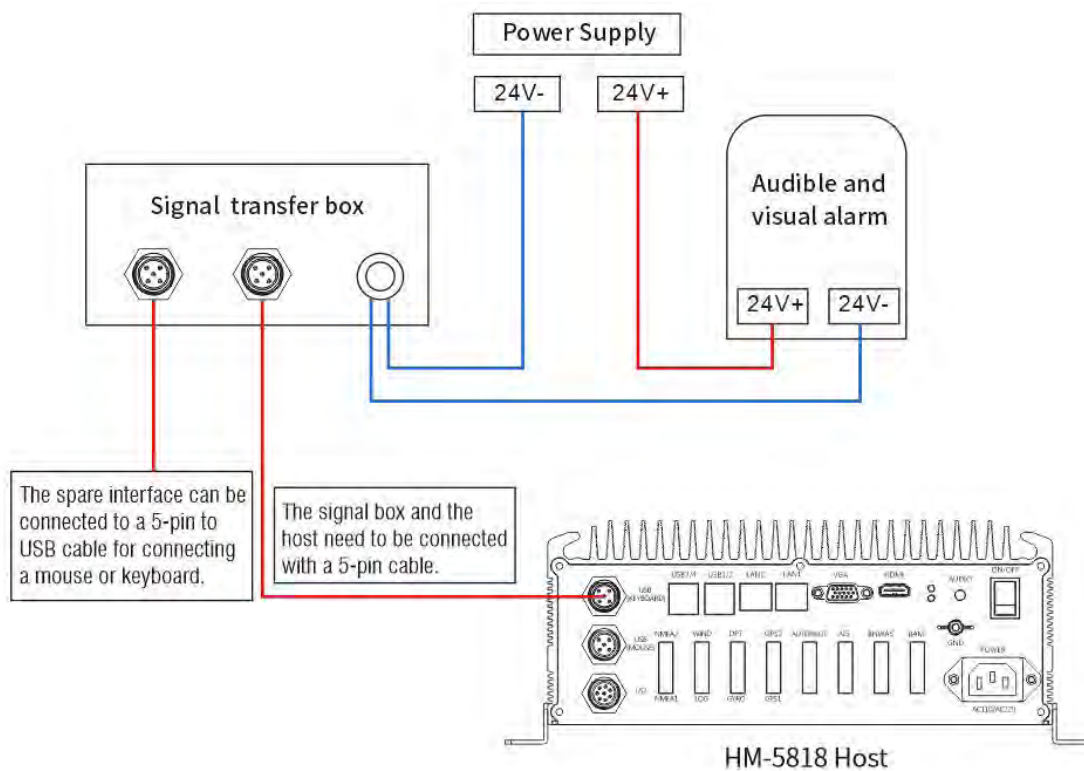

Connection diagram of host and other devices:

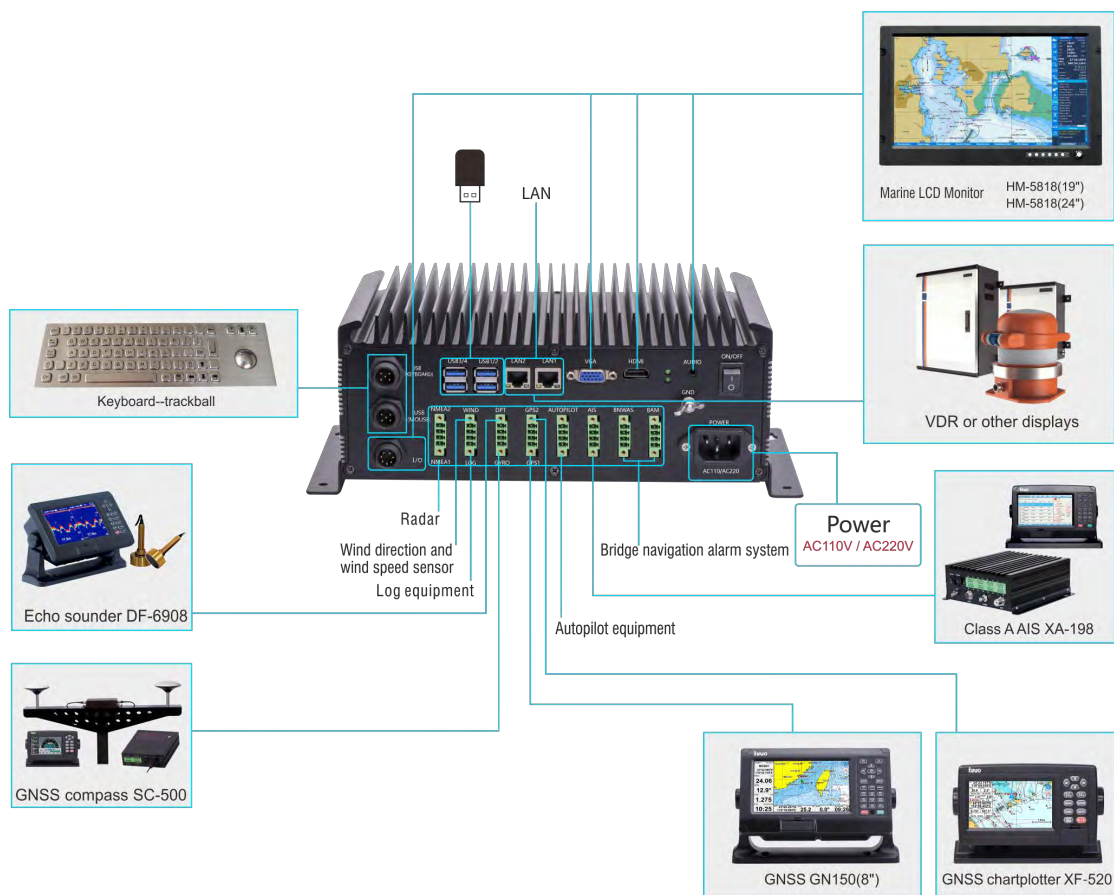

Note:

Required equipment: GPS/AIS/compass/log/VDR/BNWS/BAM,

Selective equipment: ARPA/auto pilot/anemoclingraph/fathometer, etc.

Definition of host interface:

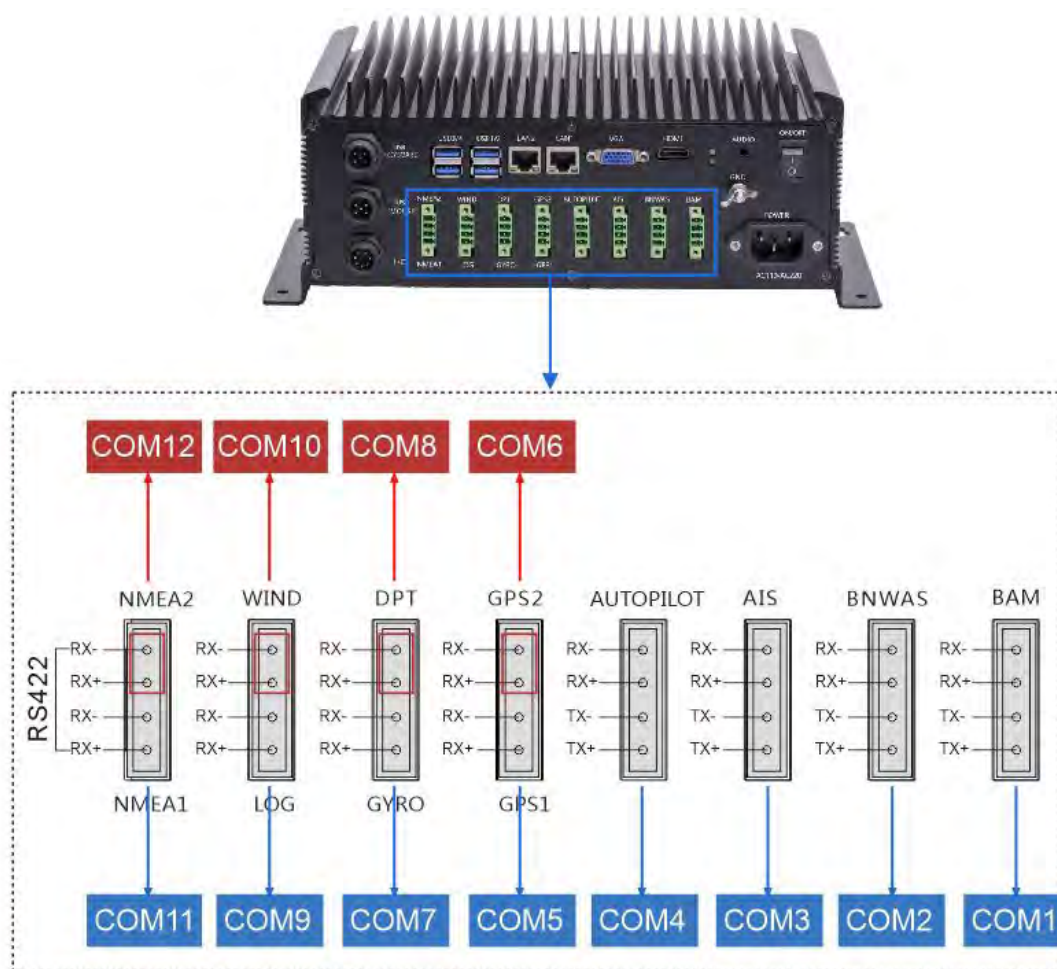

The default interface connections are as follows (Users can customize the configurations):

COM1: Building bridge alarm system

COM2: BMWAS

COM3: AIS

COM4: Autopilot equipment

COM5: GPS1

COM6: GPS2

COM7: compass

COM8: Depth finder

COM9: Log

COM10: Anemorumbometer

COM11: Reserved interface for radar or other equipment.

COM12: Reserved interface for radar or other equipment.

Signal Detection:

1) Baud Rate



Baud rate setting



2) Signal Detection

Data Display

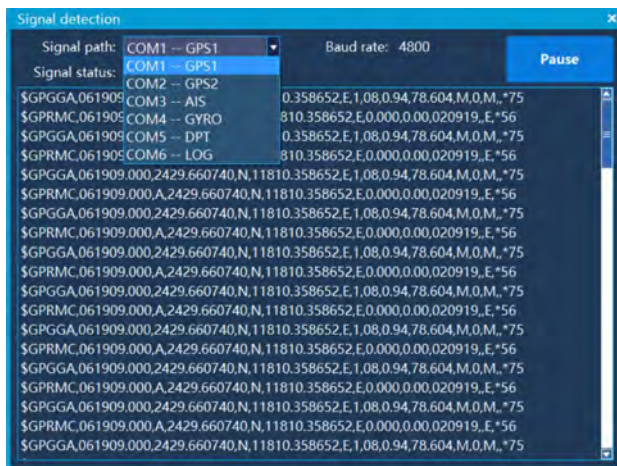

Signal channel setting



After the serial port is correctly connected, click “”, and the "Signal Detection" window will pop up, select the connected signal channel, you can see that in the "Signal Detection" window, the signal status is displayed at 100%, the color is green, and many sentences appear. When the sentence is input normally, you can check the data information in the list on the right; if the signal status is between 1% and 99%, and the color is orange, please check whether the positive and negative poles of the connection are correct or whether the interface is connected correctly.

1.COM1 : GPS1

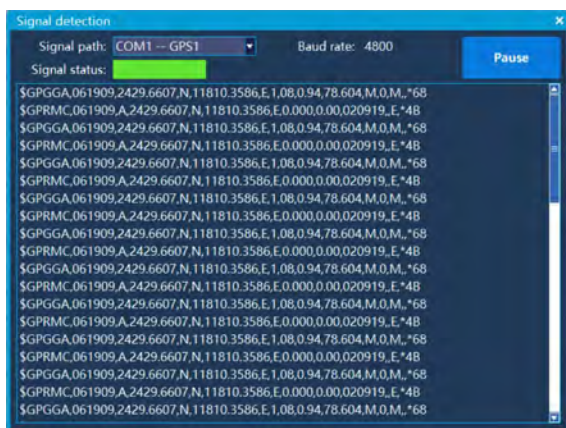

Display area

Signal Detection

2.COM2: GPS2

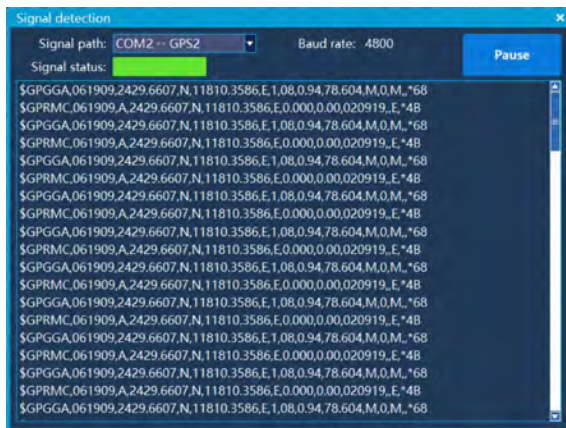

Display area

Signal Detection

3.COM4:Compass

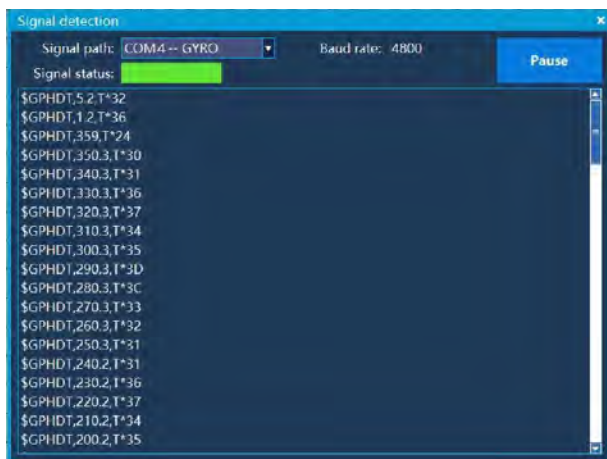

Signal Detection



Display area

4.COM6:Log

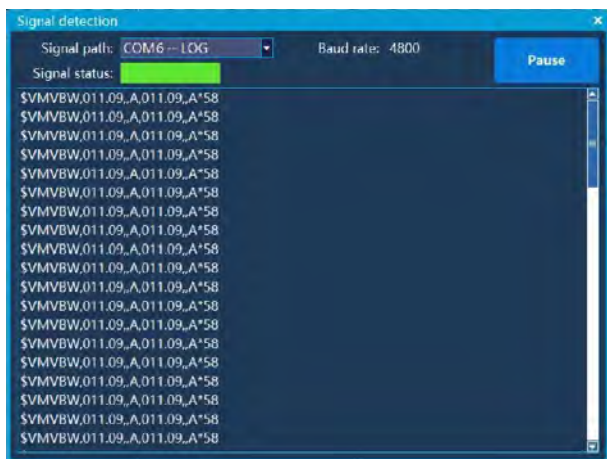

Signal Detection

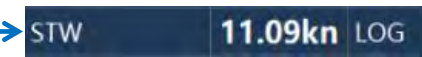

Display area

5.COM3:AIS

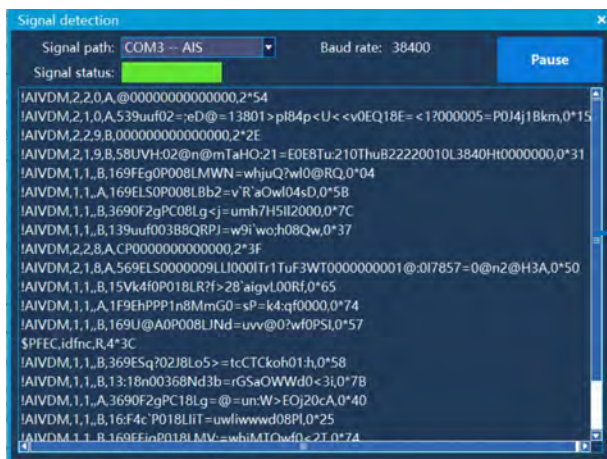

Signal Detection



Display area

6.COM5:Depth finder

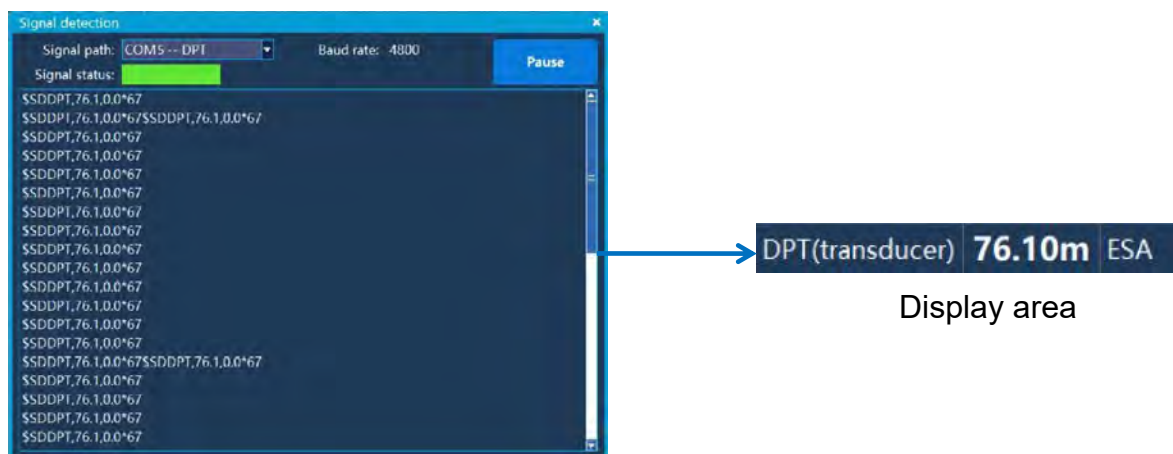

Signal Detection

Method of connecting VDR to host:



⑦ Ethernet cable (length: 2M)

The VDR is connected to the network interface LAN2 of the host through a Ethernet cable,then enter "System Settings" and set the IP address according to the network segment.



The following setting items can remain the same as the system and do not need to be configured.If users need to match the VDR, the users can change the Multicast address and Port number to match the VDR.The transmission picture format of VDR can be selected in PNG or JPG, and the time interval can be set from 1s to 15s.



Introduction to Switches:

1) This switch is the host power switch, and the user can turn it on for a long time; if the user does not use the device for a long time, please turn off this power switch.

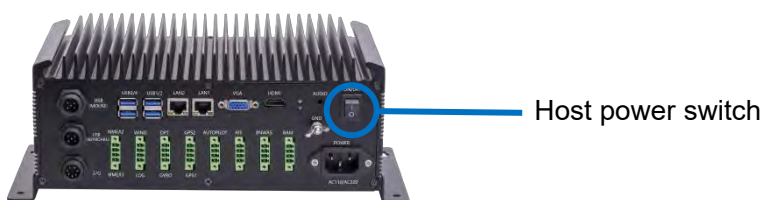

2) This switch is a host switch, short press to turn on; in the on state, long press to turn off.



3) This switch is a display switch, and the display can be turned on or off by turning the knob.



Chapter 2

Operation and Setting

This chapter will guide you to gradually become familiar with system operation and setting.



2.1 Home Screen

2.1.1 Description of Operational Interface

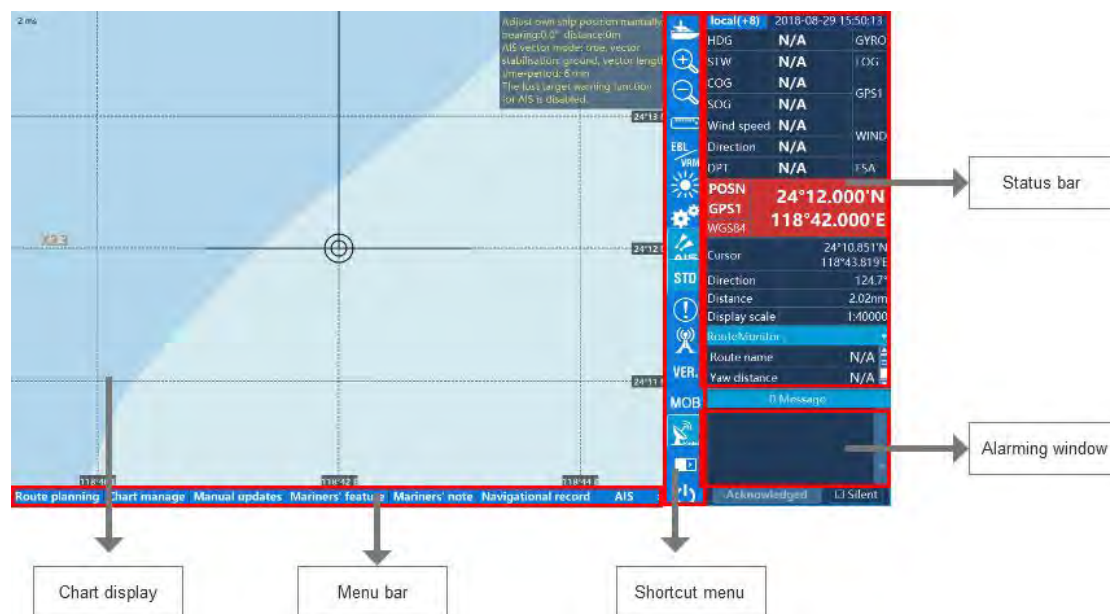

1. Time display

Setting the time by GPS. When there is no GPS signal, the user can adjust the time and



time zone of the device to adjust the time. You can switch between world time and local time by clicking the time display button

2. Data information and standard abbreviation

HDG	N/A	GYRO
STW	N/A	LOG
COG	N/A	GPS1
SOG	N/A	
Wind speed	N/A	WIND
Direction	N/A	
DPT	N/A	ESA

Data Sources

HDG: Heading of the vessel . The COG to the right of the HDG can also display GYRO.

STW: The speed of water.

COG: Heading to the ground.

SOG: Speed to ground.

Wind speed: wind speed

Direction: Wind direction

Wind: A source of data for aerovane, wind direction and wind speed.

DPT: Depth of water.

LOG: Compass.

GYRO: Gyro.

DPT: depth sounder

RADAR: Radar

POSN GPS1: Position coordinates. GPS1 is the source of the signal.

WGS 84: Benchmark

3.Cursor information

Cursor	24°10.710'N 118°45.868'E
Direction	110.1°
Distance	3.76nm
Display scale	1:40000

4.Display scale

Display scale	1:40000
---------------	---------

5.Navigation monitoring

Display basic information about route monitoring.

Route Name: Displays the name of the currently monitored route.

Yaw distance: The distance the vessel exceeds the safe distance and there is an alarm.

RouteMonitor	
Route name	Route000
Plan speed	0.00kn
Plan direction	270.0°
Save distance	0.10nm
Yaw distance	2.96nm
Yaw angle	078.6°
Crt monitory pnt	4
DTW	9.44nm
TTG	00d 00h 00m
Plan turn radius	0.10nm
Plan turn rate	0.00°/s
Next monitory p	5

Yaw angle: shows the course of the vessel

Distance from the monitoring point: the distance from the vessel to the monitoring point.

Current monitoring point: The waypoint number and the waypoint name that the vessel is about to arrive.

Next monitoring point: the next arriving waypoint number and the waypoint name of the vessel .

Safety distance: According to the system settings, the user-defines safety distance .

Estimated arrival time(ETA): The estimated time it takes for the vessel to reach the

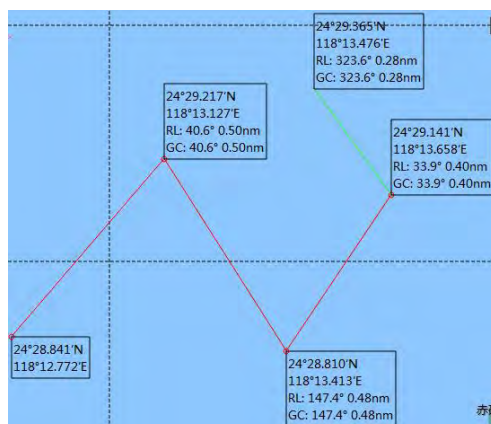

upcoming monitoring point.

Total time remaining: The time it takes for the vessel to arrive at the destination.

Total remaining voyage: The remaining voyage at the end of the vessel .





Planned speed: Shows the speed of use based on calculations in the voyage plan.

Planned heading: Shows the current course of the vessel based on the route.

Planned Turning Radius: Shows the turning radius of the vessel at the monitoring point.

Planned Steering Rate: The number of angles per second, calculated from the predicted speed and steering radius.

2.1.2 Quick Operation Menu

- Center Own-vessel position
- Click , show current vessel position on the chart.
- Up mode
- Click , then North Up can be chosen.
- Zoom up the chart: click  to zoom up the chart.
- Zoom in the chart: click  to zoom in the chart.
- Distance measurement

By clicking , distance and azimuth between any two or more points can be measured.

Measuring the distance from the mouse click, you can measure the distance and orientation between any two or more points. Each point position information box displays the coordinates, the orientation and distance of the major circle and the constant line from the previous point. Among them, the RL data represents the lateral line orientation and distance; the GC data represents the orientation and distance of the large circle route.

- Electronic bearing line\active distance circle

With a mouse click , you can quickly choose in a vessel -centric mode or free-moving mode.

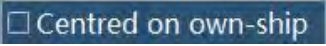
Select , centered on the vessel 's position, as shown below:



The specific information is displayed in the function window, as shown below.

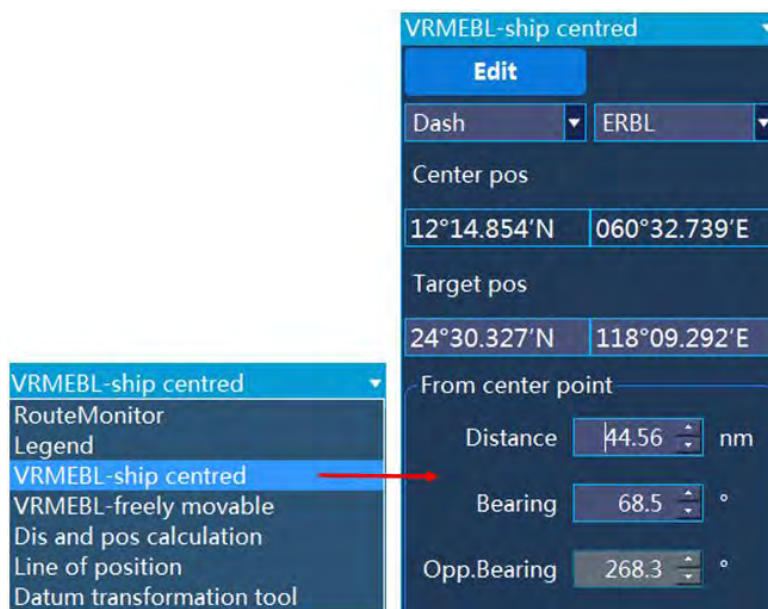

You can edit and modify the electronic bearing line by clicking the button on the window . The distance, azimuth, and reverse azimuth of the "relative center point" can be set manually.

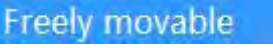
Select , the center point position is free to choose, the other operations are the same as above.

The specific information is displayed in the function window as shown below.



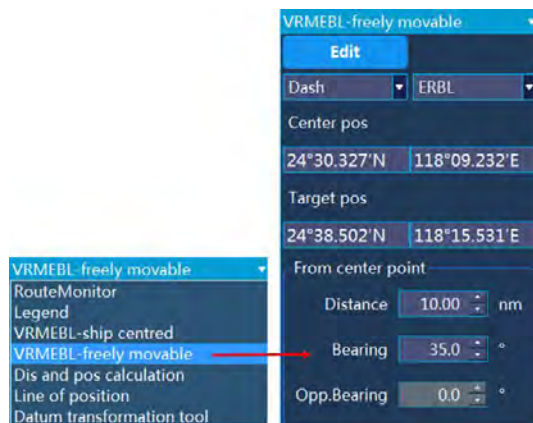

You can edit and modify the electronic bearing line by clicking the button **Edit** on the window. The distance, azimuth, and reverse azimuth of the "relative center point" can be set manually.

- Display mode

Click , display mode switches in day , cloudy , night mode .

- AIS displays

Click , you can quickly switch on/off to display the AIS vessel on the chart.

- Display chart

Click , The chart shows a mouse click and you can quickly switch to the chart standard display.

- Alarm list

Click , you can quickly view history alarm.

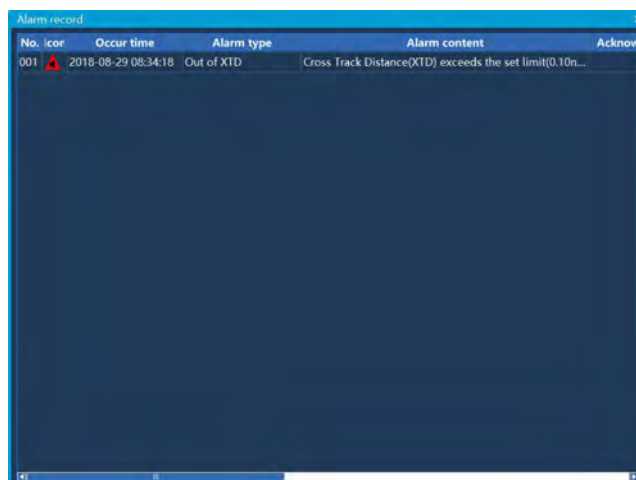

- signal detection



Click , checks the status of the external signal access signal.

When the signal status bar is green, the signal is normal, as shown in the figure:

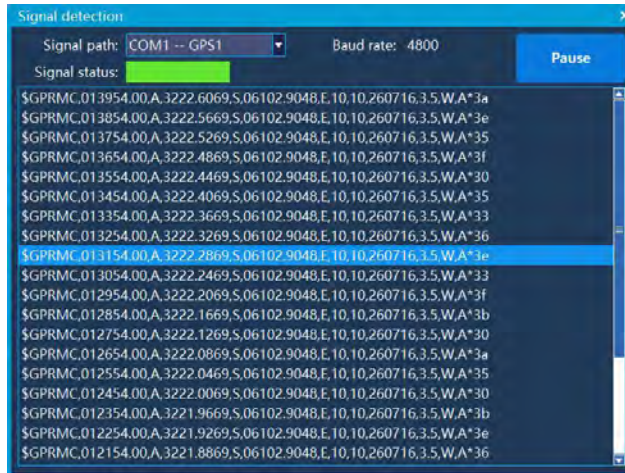

When the signal status is yellow, the signal is abnormal, as shown in the figure:

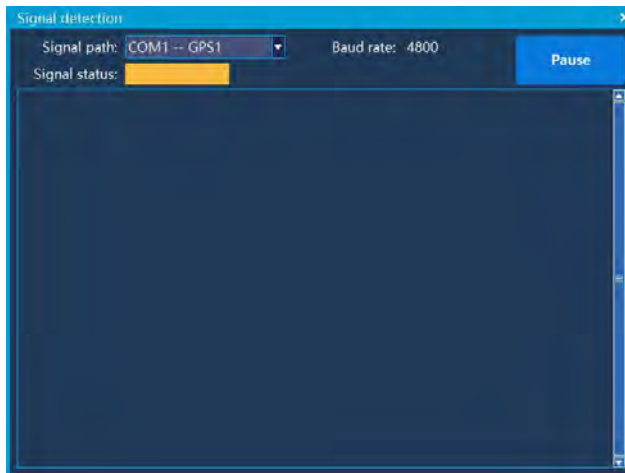

- System information



Click , check the system information, including system version and chart version.

The date of the chart update should be sorted and viewed in the release date of the chart management.



- MOB

Click , record a MOB position of the emergency landing point basing on the current position.

- The radar switch

Click , you can quickly switch the radar icon display function. Light means the radar icon is turned on.

- Shortcut menu switch

Click , quickly open and close the shortcut menu.

- Turn off the system

Click , turn off the system.

2.2 Route design

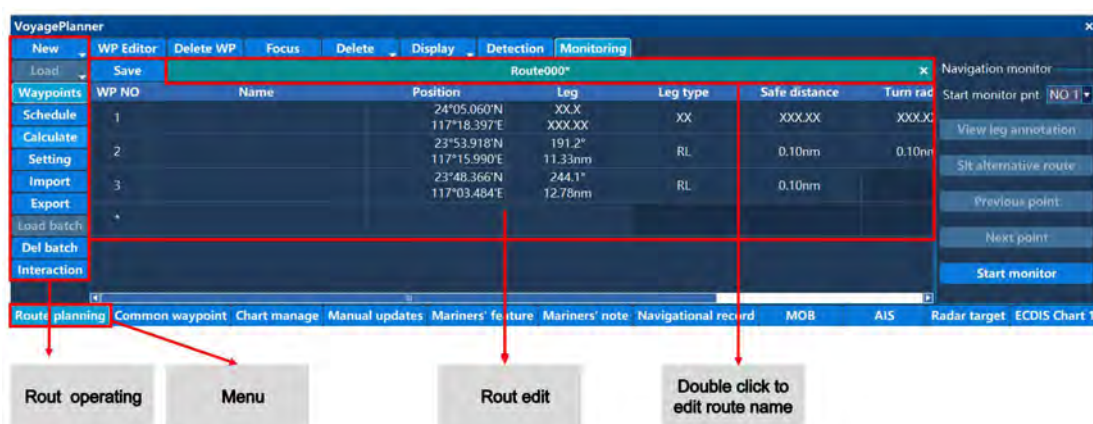

2.2.1 New route

Click "New Route", move the cross cursor, click the left button to add a waypoint, and right click to end the route design. After adding the waypoints required for the route, click on the menu "Save Route" button to save the newly created route. As shown below:



In the route editing area, you can view the information of the waypoints in the route, including the total number of waypoints, name, latitude and longitude, range type, range, safety distance, steering radius and other parameters can be edited.

In the route editing area, select a waypoint and click the right mouse button to “insert waypoints” or “delete waypoints”.

Double-click the route name to edit the name of the route.

2.2.2 Editing waypoints

Click the "Edit Waypoint" button, the mouse will automatically jump to the chart center, and enter the edit waypoint state.

Click the waypoint 1 on the route, move the cursor, and click the left button. The waypoint 1 is moved to the specified position of the cursor, and the right button is clicked to cancel the move. To re-select the waypoint, click the “Edit Waypoint” button, re-select the waypoint, click the left button, the waypoint is moved to the specified position of the cursor, right click to exit the edit waypoint operation. You can save the edited route by clicking the menu "Save Route" button. Click the left button above the route segment between the two waypoints to insert the waypoint. When you need to insert the waypoint at a position other than the route segment, you can first insert the waypoint on the route segment and then move the cursor to the desired insertion. position.

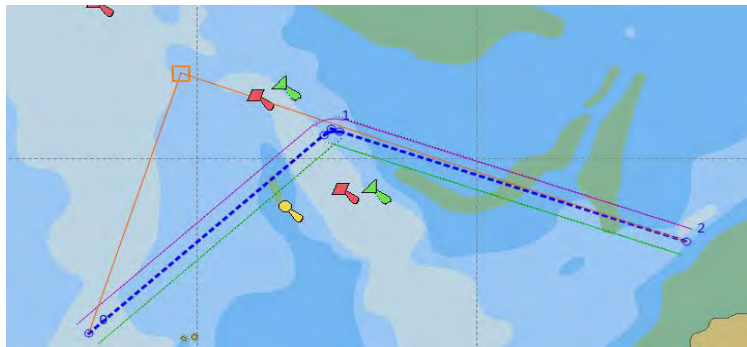

2.2.3 Deleting waypoints

Click the “Delete Waypoint” button, the mouse will automatically jump to the chart center. At this time, enter the delete waypoint point, select the waypoint to be deleted, click the left button, and the selected waypoint will be deleted. The waypoint number following the deleted waypoint is changed and numbered sequentially. Right-click to exit the status to delete the waypoint and click the “Save Route” button to save the edited route.

2.2.4 Locking the route

Click the “Lock Route” button, the currently selected route will be fully displayed in the center of the chart at the maximum scale. Before the route is locked, as shown in the

figure:



2.2.5 Deleting a route

Click the “Delete Route” button to pop up the route list as shown below:

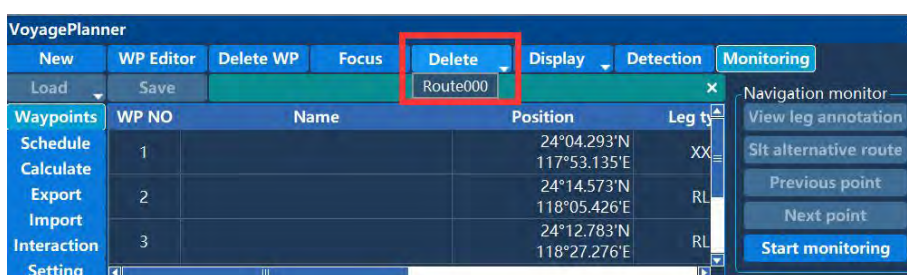

Select the name of the route that needs to be deleted, and click the left button to pop up a prompt message asking if you want to delete the route. Click [YES] to delete the route and [No] to cancel deleting it.

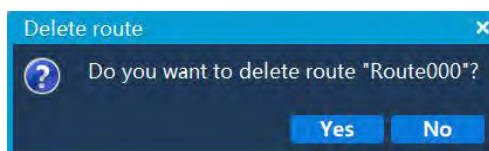

2.2.6 Display Settings

Click the "Display Settings" button to call a list of display settings as shown. The display settings include displaying the waypoint number, the waypoint name, the steering arc, and the safe distance line.

Checked items are indicated to display, unchecked items are indicated not to display.

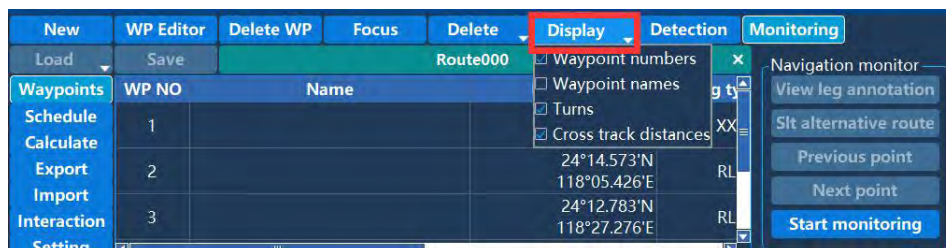

2.2.7 Route detection

On the currently selected route, click the “route detection” button, the system will detect the current route and give a prompt, as shown below:

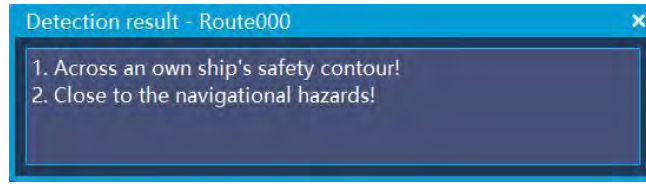

After the route detection prompts, the test results will be highlighted on chart screen, as shown below:

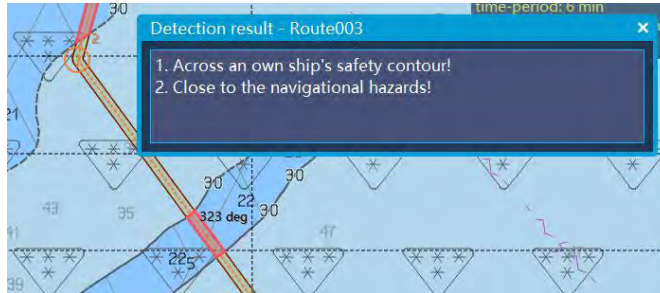

Please follow the test results to modify this route.

2.2.8 Loading the route

Click the "Load" button to pop up a list of all saved routes that are not displayed. Click one route in the list and the route information will be displayed in the route point list as shown:

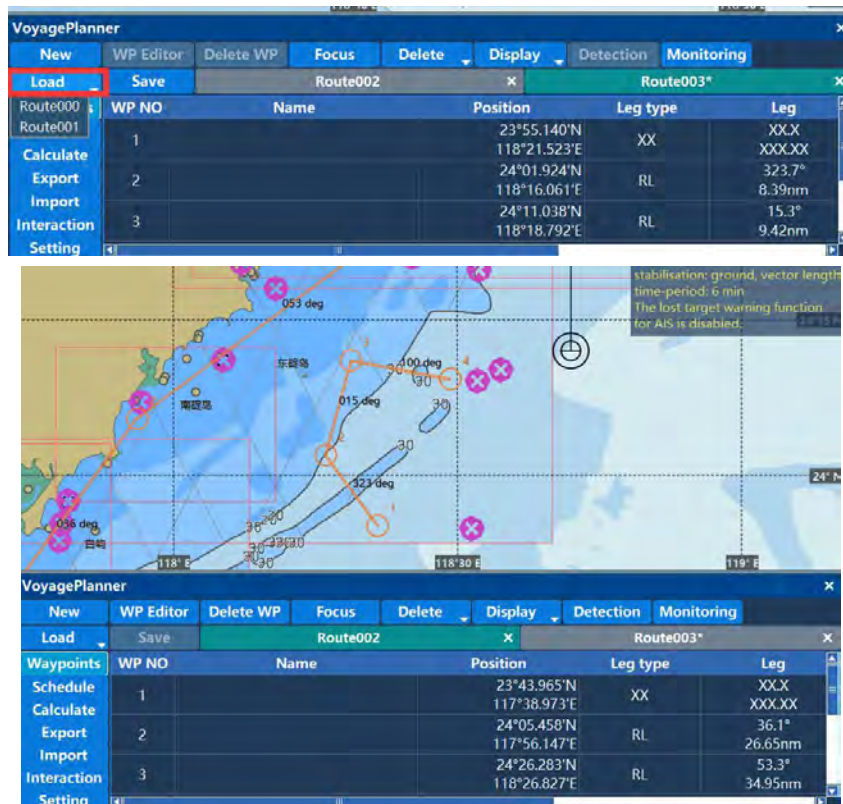

2.2.9 Save the route

If the currently selected route has not been saved or saved but has been modified, click the "Save" button to click Save.



2.2.10 List of waypoints

The route is loaded first, and the information of each waypoint of the route will be loaded into the waypoint list. The waypoint list shows the waypoint name, latitude and longitude, range type, range, safe distance, steering radius, and so on. Click the left mouse button to select the entire row, click the right mouse button to pop up the operation menu as shown:

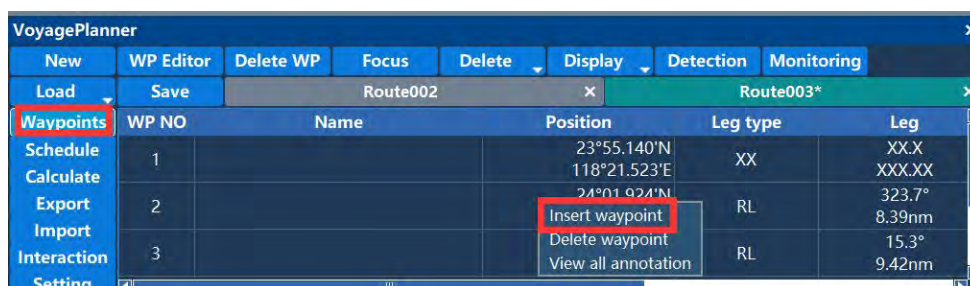

Select "Insert Waypoint" to insert a new waypoint in the selected row. The default latitude and longitude coordinates of the waypoint are the coordinates of the center point of the route segment. Select to delete the waypoint and the waypoint will be deleted.

Double-click on a column in the list to enter the editing state. Cells with "XX" and gray areas are un-editable.

Double-click on the waypoint name unit to enter the waypoint name edit, enter the name of the waypoint via the keyboard, and left click on the location outside the edit zone to exit the waypoint name edit.

Edit the latitude and longitude coordinates, double click the latitude and longitude items as shown:

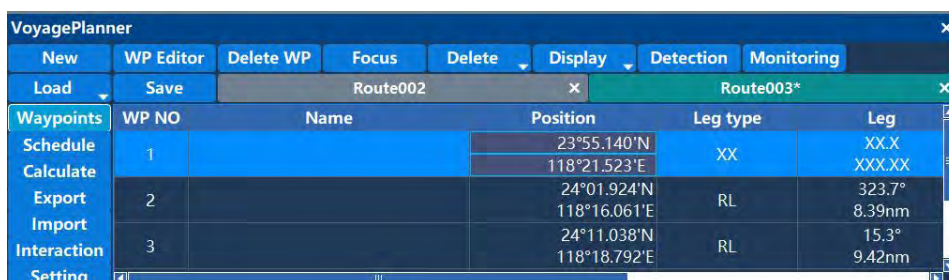

The mouse moves up and down by 5, and the left and right movement changes by 1. The value can also be adjusted via the up and down keys of the keyboard. After

modifying a value, click the left mouse button to enter the next item of modification. Right click to enter the modification menu, select Apply Settings to save, or cancel than the latitude and longitude values will not be changed.

Viewing the comment is that the user can view the navigation note information added by the crew on this route.

Double-click the Leg type unit to enter the voyage type edit, which pops up as shown:

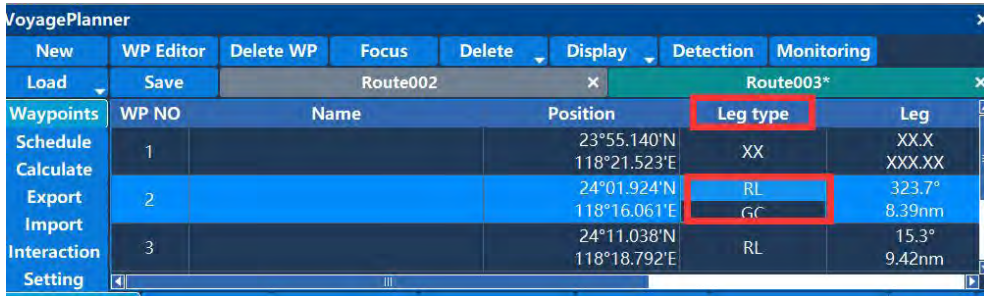

The calculation of the selection of the constant line voyage will be calculated according to the constant line, and the calculation of the voyage of the large circle will be calculated according to the route of the big circle. Double-click the voyage unit to enter the voyage edit as shown:

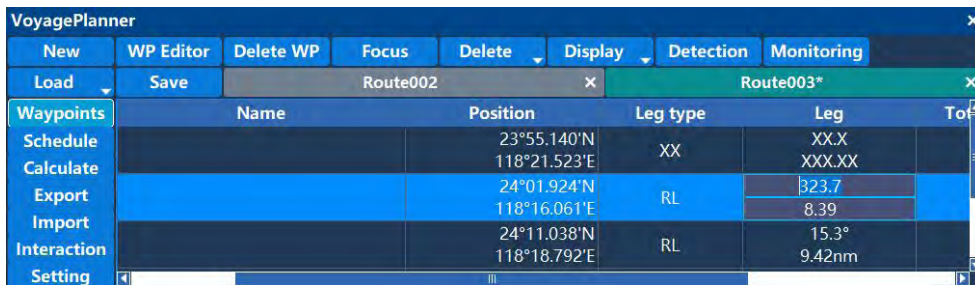

The angle is the orientation relative to the previous waypoint, and the distance is the distance from the previous waypoint. Determine the latitude and longitude coordinates of the waypoint by adjusting the angle and distance.

The total distance is the distance from the first waypoint of the route to the current waypoint. The part cannot be edited.

The safety distance data is used for route detection and yaw alarms. You can double-click to edit and input the values according to the route design.

The steering radius is the radius of the route steering arc, and the set value is based on the steering ability of the actual navigation of the vessel .

2.2.11 Voyage schedule

First load the route, click on the voyage “schedule”, and enter the voyage edit list as

shown:

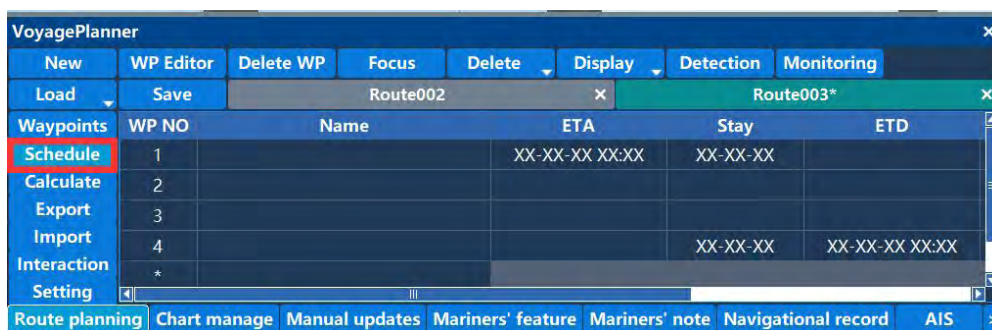

The planned route list consists of the waypoint name, estimated arrival time, stay, estimated departure time, estimated sailing time, total time, speed, and average speed. The waypoint name, estimated arrival time, stay, estimated departure time, and speed can be edited by the user.

Double click on the estimated arrival time (ETA) to enter the estimated arrival time as shown in the figure below:



The display date and time box is divided into five input parts: year, month, day, hour, and minute. Click the left mouse button to switch the input part, right click to confirm the cancel menu, up arrow to add 1 and down arrow to subtract 1.

Double click on the dwell part to enter the dwell time edit as shown:

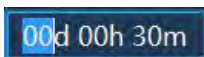

The display time input is divided into three input parts: day, hour and minute. The left mouse button clicks to switch the input part, the right button pops up to confirm the cancel menu, the upper shift increases 1 and the lower shift decreases 1.

The expected edit of the arrival time is consistent with the edit of the expected departure time.

Double click on the speed unit to enter the speed edit as shown:



Click the left mouse button to confirm and right click to cancel. Up arrow to add 1, down arrow to subtract 1. left arrow to add 0.1 and right arrow to subtract 0.1.

After the corresponding information of the voyage schedule is completed, click the calculation button and the system will automatically calculate other information. If the information is incorrect, the error message will be displayed at the bottom of the calculation button.

2.2.12 Route Export/Import

Click on the left column **Export**, to export the route of the current device to the USB flash drive. Note that you will need to insert a USB flash drive at this time. When you choose to save, you need to select the correct USB address. as follows:

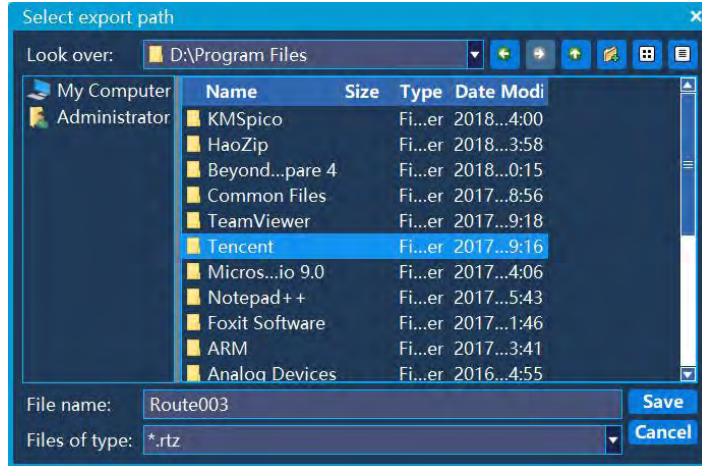

Click on the left column **Import** to import the route from the USB flash drive to the ECDIS device. Select the correct U disk address and select the route data to be imported. The screen is as follows:

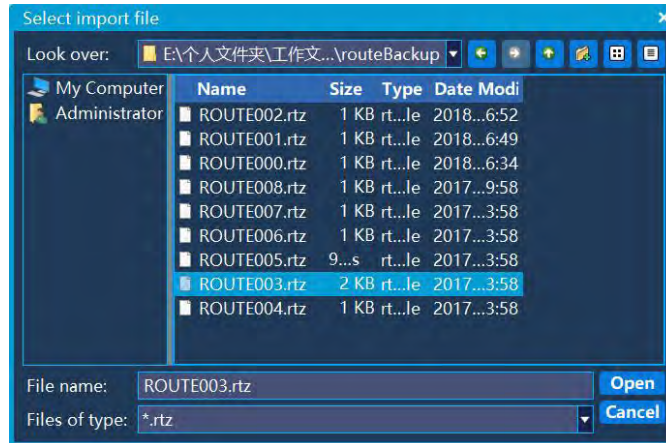

After clicking "Open", the route is imported to the ECDIS device.

2.2.13 Interaction Log

The interaction log is an interaction record between the host and the backup system. When connecting to the backup system, you need to set the device as the host or backup system, as follows:

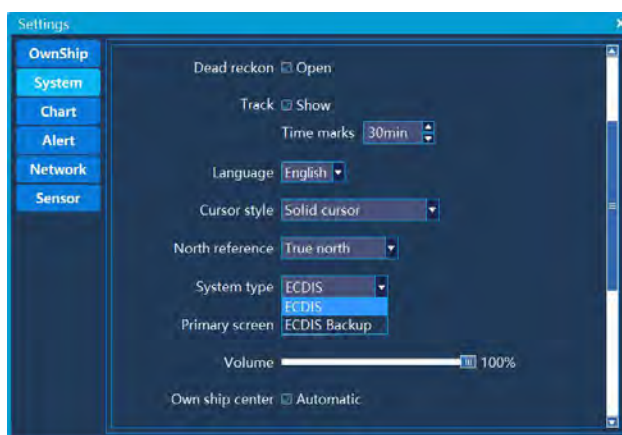

Click the shortcut key [Settings] on the right, select the “System” interface, and select the device in the system type to be ECDIS (Host) or ECDIS Backup (ECDIS Backup System). When the host and the backup system interact, view the interaction log, as shown in the following figure:

Date time	Route name	Type	Operator type	File Transfer	Application
17-06-07 10:36:13	计划航线011	Send	Add	Success	Refused
17-06-07 10:36:04	计划航线005	Send	Add	No response	No applicable
17-06-07 10:32:40	计划航线004	Send	Add	No response	No applicable
17-06-07 10:22:51	Route010	Send	Add	Success	Application
17-06-07 10:22:21	Route010	Send	Add	Success	Pending
17-06-07 10:20:32	Route009	Send	Add	Success	Application
17-06-07 10:20:02	Route009	Send	Add	Success	Pending
17-06-07 10:17:44	Route007	Send	Add	No response	No applicable
17-06-07 10:07:18	Route006	Send	Sync	Success	Application
17-06-07 10:07:17	Route005	Send	Sync	Success	Application
17-06-07 10:07:16	Route004	Send	Sync	Success	Application
17-06-07 10:07:15	Route003	Send	Sync	Success	Application

2.2.14 Settings

The setting of the route design is to set the default values of the safety distance and the steering radius during the design a route. The default value of the safety distance and the steering radius when designing the route design is the value at the time of setting.

Check the route monitoring display comment. When the route is monitored, the route will cross the commented area or the object pop-up comment box. If you uncheck the box, the prompt box will not pop up when you cross the commented area. The setting interface is as follows:

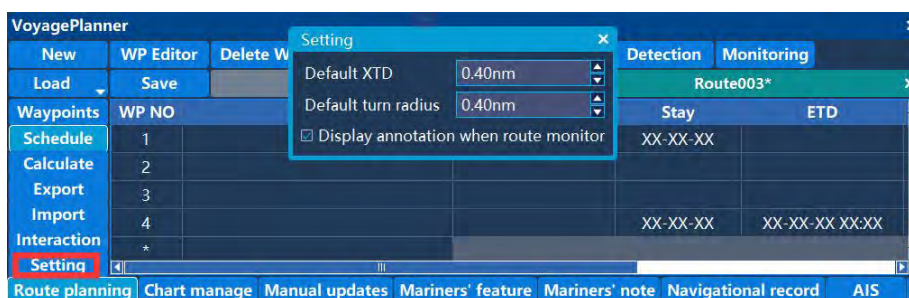

2.3 Route monitoring

Load a route, select “Monitoring”, the route monitoring window will appear in the right window, select “Start Monitoring”, the following window:

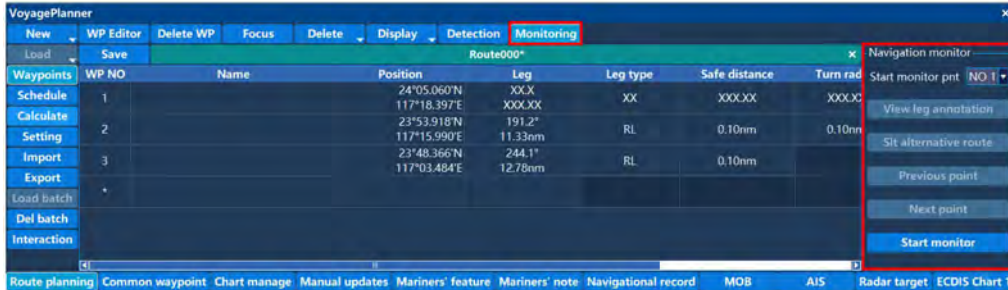

After the selected route starts monitoring, you can view the detailed information of the route monitoring in the operation status bar, as shown in the figure:



Among them, the estimated arrival time, the total remaining time, and the planned speed need to be set in the voyage schedule.

Click the next monitoring point button to start monitoring the next waypoint, and the current waypoint becomes the next monitoring point. Click to view the current segment comment, then the current segment comment pops up. If there is a comment, the annotation information is displayed, as shown in the figure:

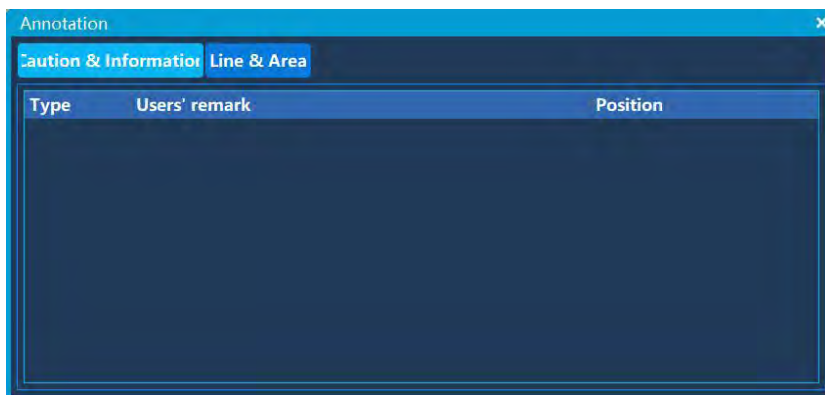

During the route monitoring process, all alarms, warnings, and prompts will give corresponding alarms in the alarm window in the lower right corner of the screen. As

shown below:

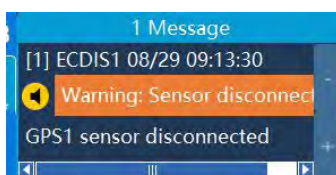

Among them, check the silence, the alarm will not sound an alarm. There is a corresponding alarm sound when the alarm is unchecked.

2.4 Common waypoint

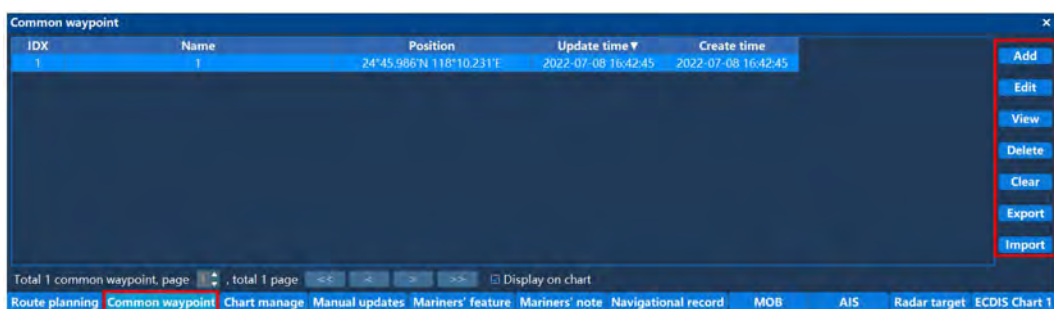

Click “Add” to add common waypoints, as shown in the figure:

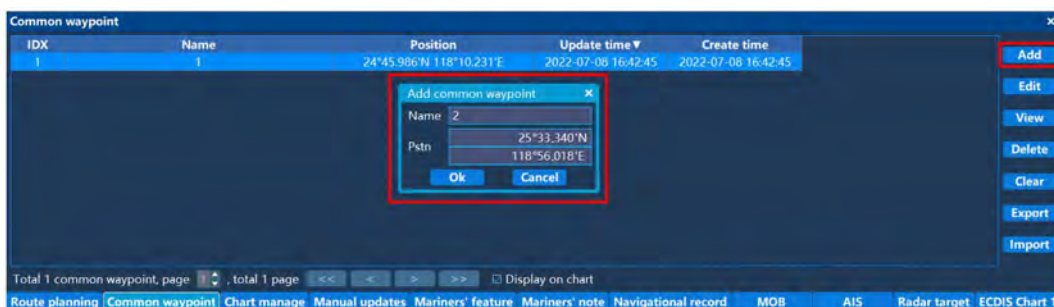

Select the corresponding waypoint in the list and click “Edit” to edit the name and location of the waypoint, as shown in the following figure.

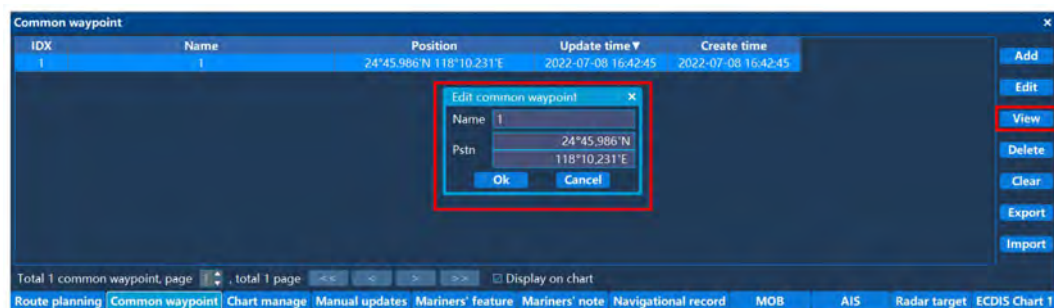

Select the corresponding waypoint in the list and click “View”, the chart will jump to the current waypoint location.

Click “Delete” or “Clear” to delete the selected waypoint or clear the list of frequently used waypoint.

Click “Import”, “Export” to import the waypoints into the device or export the waypoint of the device.

2.5 Electronic chart management

For the electronic chart loading, the third chapter of this manual will focus on the introduction. See Chapter 3 for more information on chart management. The electronic chart management window is as follows:

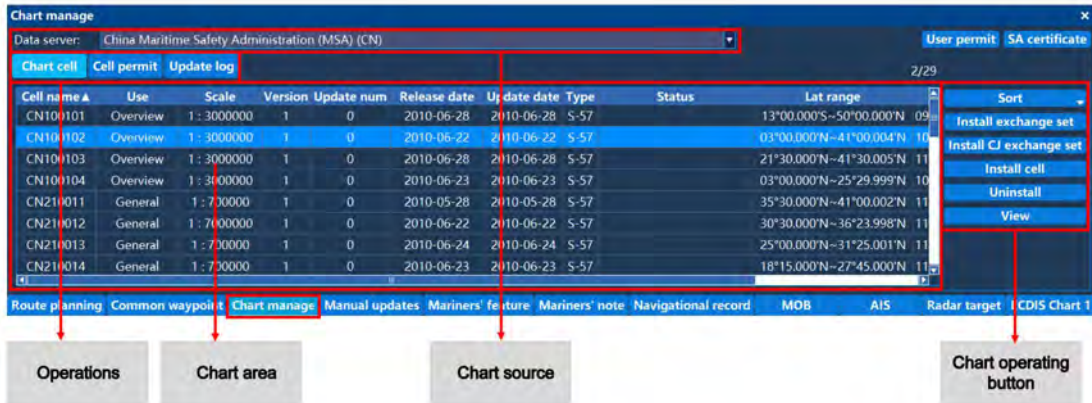

2.5.1 Chart unit

Click on “Chart Cell” to view the detailed information of the chart files that have been installed in the current system, including chart unit name, chart type, scale, version number, update number, release date, update date, latitude and longitude range and other information.

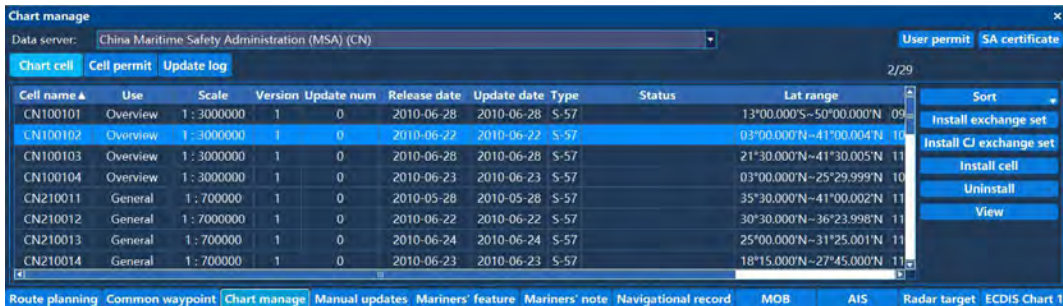

Click the “Sort” button to sort the chart display. Support unit name ascending, descending, scale ascending, descending, issue date ascending, descending and other sorting methods. As shown in the figure, after selecting the unit name in descending order, it is displayed as follows:

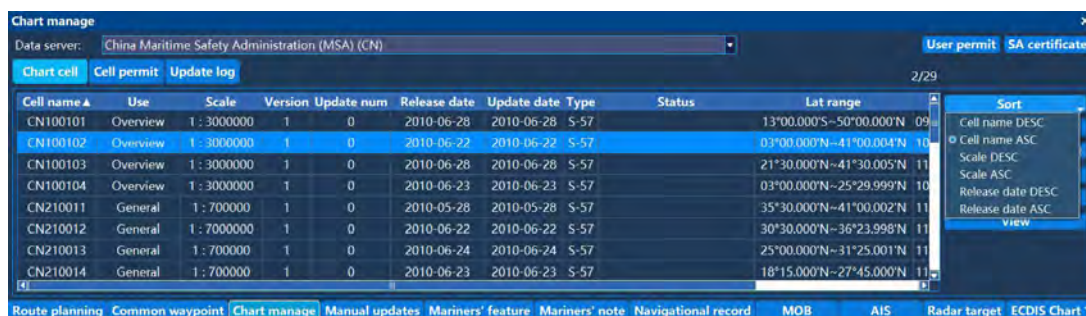

Click the “Install Exchange Set” button to install an encrypted license chart (of type S-63) that has been licensed.

Click the “Install Cell” button to install a free chart (S-57).

Select a chart and click the “Uninstall” button to uninstall the chart.

Select a chart, click the “View” button, and the system interface will jump to the chart area.

2.5.2 Unit License

Click “Unit License” to view the detailed information of the chart file installed in the current system, including the unit name, expiration date, status, service level, version number and other information.

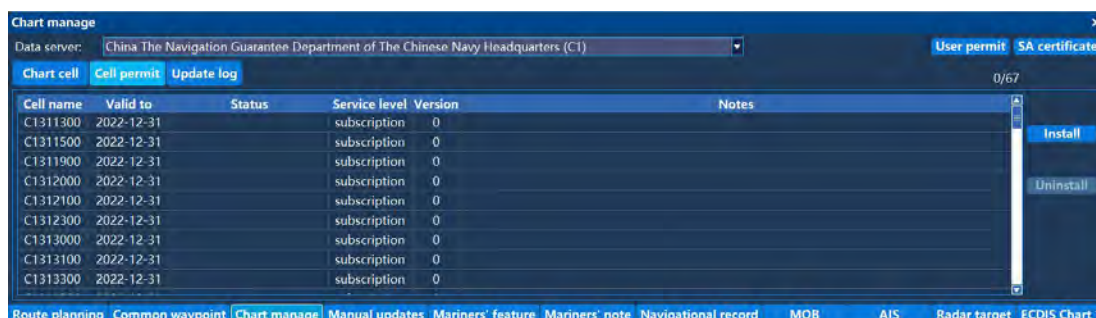

2.5.3 Update log

Click "Update Log" to view the update status of the current system chart, including update time, unit name, status, version number, update number, type, and whether abnormal prompts appear.

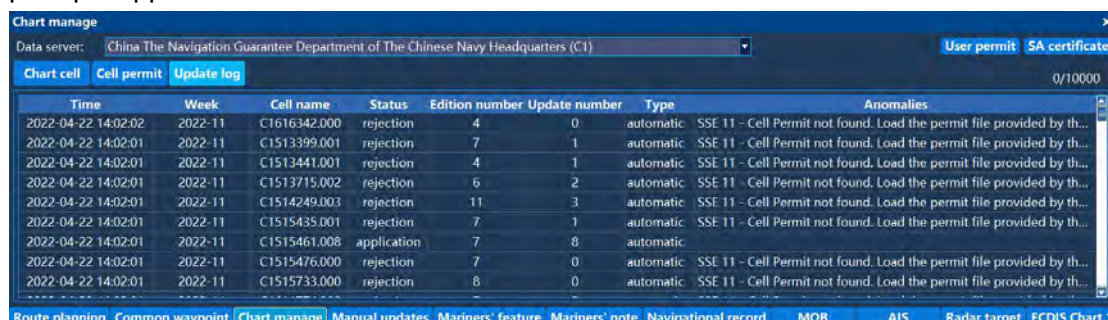

2.5.4 Data Service Provider

At the top of the chart management window, you can select the chart data service provider to view the chart for the corresponding chart service provider. As shown below:

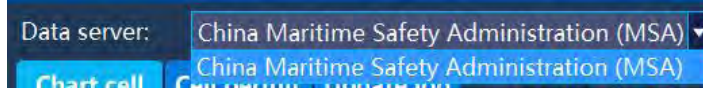

2.6 Manual update

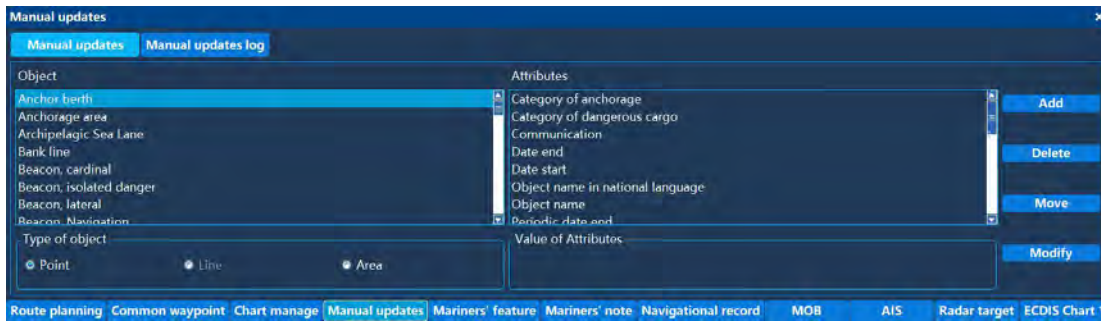

Manual update refers to the way the user manually adds the object to update the chart information.

Manually updated object objects, in the route design and route monitoring operations, will be correspondingly detected and alarmed.

The object that is manually updated by the user is clearly distinguishable from the original object of the chart on the chart display (the orange mark is added below the object mark) as follows:

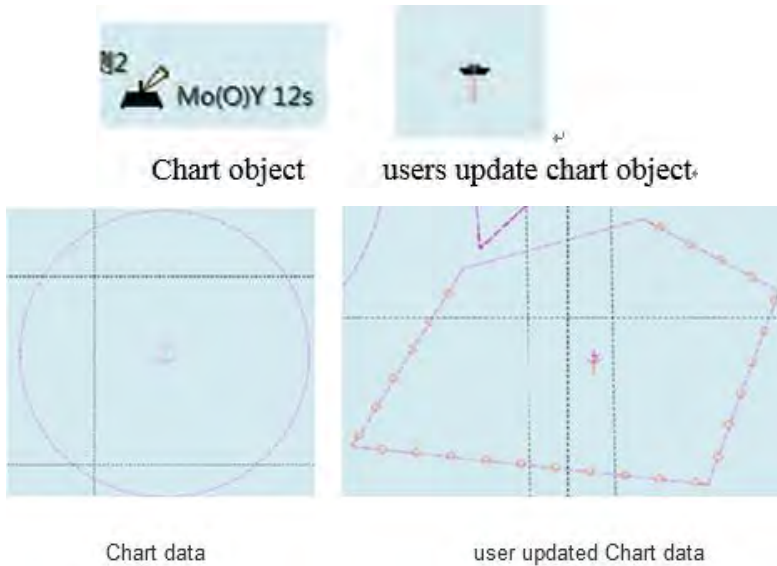

Manually updated objects that users can add are added or edited or deleted by the object attributes of points, lines, and polygons.

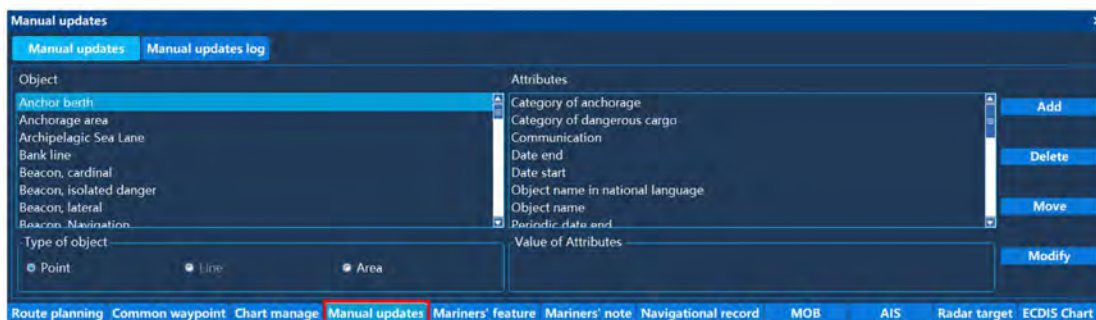

2.6.1 New object

In the "Object" window on the left side of the window, select a type to add the object, then select "Properties" on the right side of the window, select the point, line, and area according to the "Identity Type". After selecting and clicking "Add", the cursor will automatically jump. Go to the center of the chart screen. Click the left mouse button to add the object to start. Click the right mouse button to exit the add object status.

2.6.2 Deleting objects

When you want to delete a object, click "Delete", then use the cursor to select the object to be deleted. After selecting a target object to be deleted, a pop-up window will appear as follows:

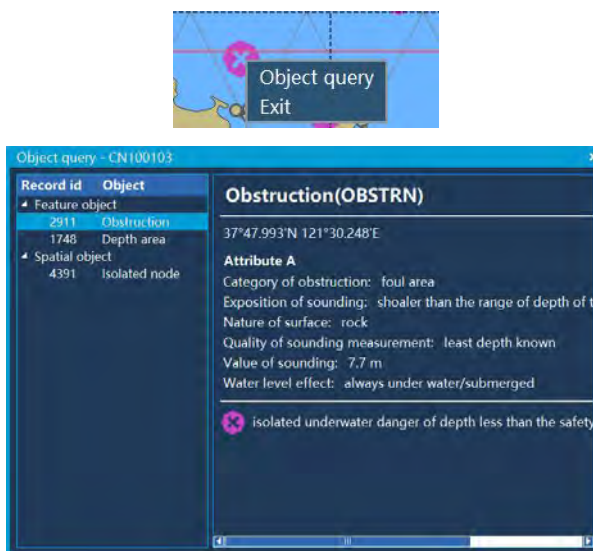

After clicking the "Delete" button, the system will confirm whether to delete again, the window is as follows:

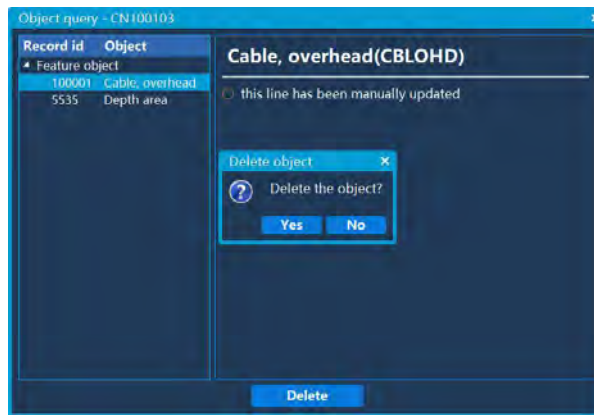

Click "Yes" to complete the deletion of the object.

2.6.3 Moving objects

When you want to move the object, click the "Move" button to select the object to be moved on the chart. At this time, the object will pop up as follows:

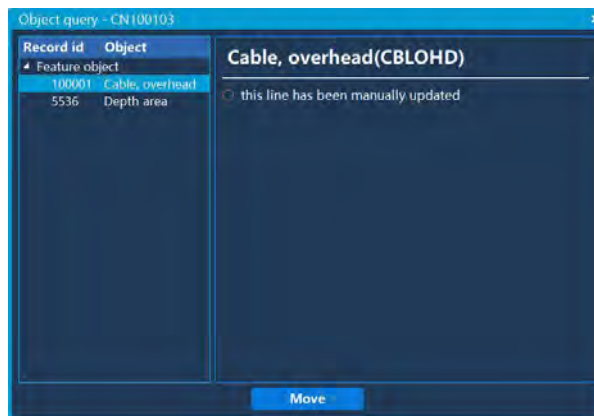

Select "Move", move the cursor to the confirmed position, and click the left mouse button to finish the object movement.

2.6.4 Correcting the object

Select the "Modify" button and the cursor will automatically jump to the chart. Select the object to be corrected and click the left mouse, as the following window:

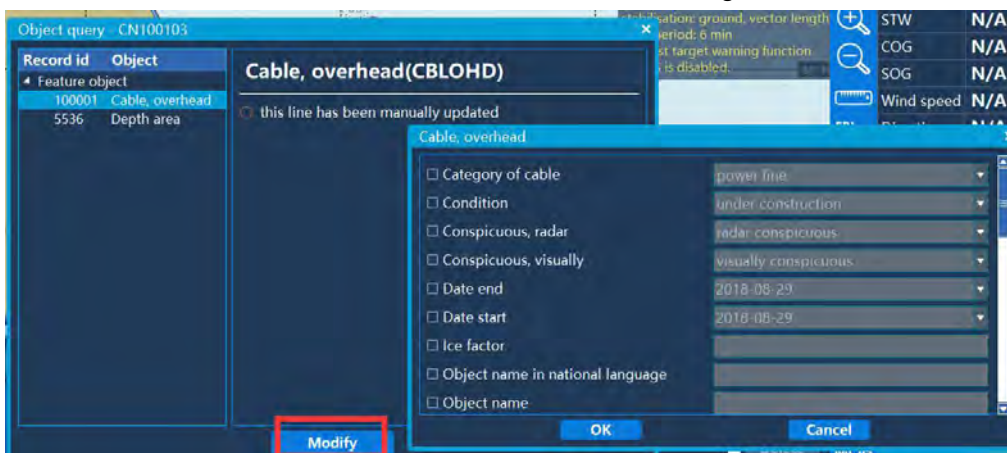

Edit the window based on the modified information. After confirming the information, click

"OK" to save the modified object information.

2.6.5 Manually updates

The manual update log records all the object information added, deleted, and modified. This log can only be viewed, cannot be deleted, and cannot be modified.

Time	Operation	Cell	Object	Type	Updated Object Position	Move Object Cell	Object ID
2018-08-29 09:48:11	Move	CN100103	Cable, overhead	Line	37°48.620'N 129°35.012'E	CN100103	36°4...
2018-08-29 09:46:24	Add	CN100103	Cable, overhead	Line	37°48.620'N 129°35.012'E		

2.7 Mariners' feature

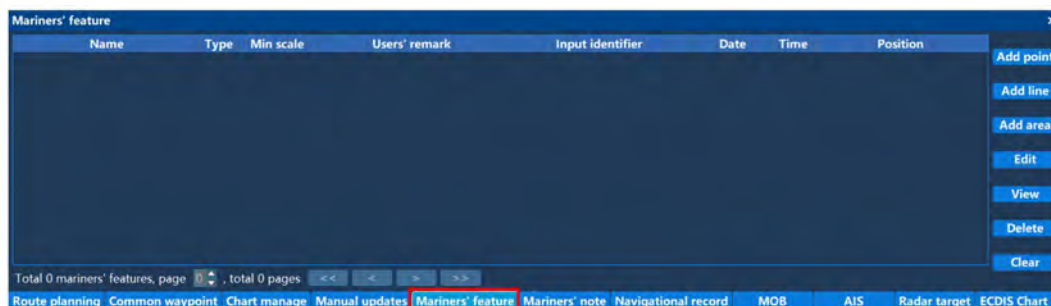

Note: When operating the Mariners' feature, confirm whether the Mariners' feature display is selected firstly, as follows:

Enter the settings, select " Mariners' feature " in "Chart" and check " Mariners' Note " .

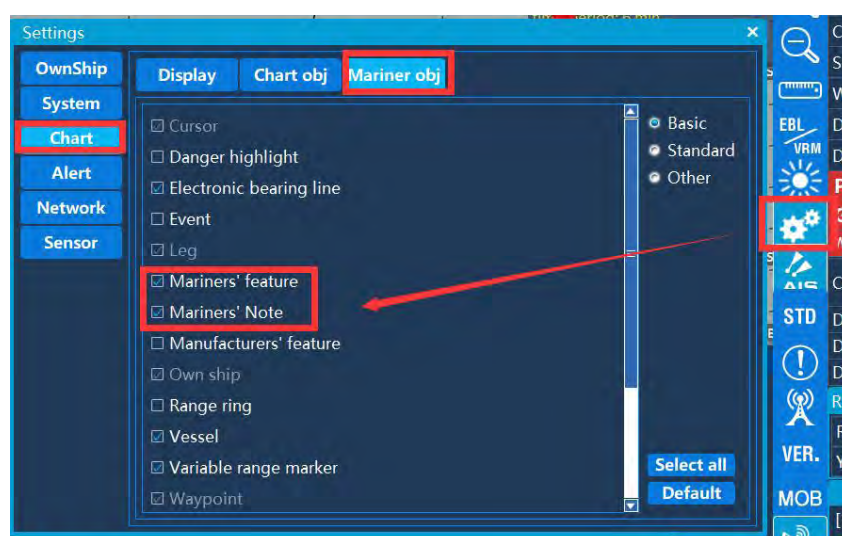

“Add Point”: Click “Add Point” and then go to the chart to select the specified position , press “OK” and then it would be popped up the edit window, edit the information, and

press “OK”.As shown below:

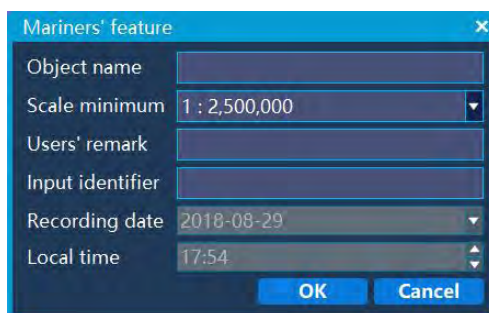

“Add Line”: Click “Add Line” and then go to the chart to select the specified position , press “OK” on different area to add a line successfully, press “Cancel” to pop up the edit window, and after editing, press “OK”. As shown below:



“Add Area”: Click “Add Area” and then go to the chart to select the specified position , press “OK” on different area to successfully add a certain area, press “Cancel” to pop up the edit box, and after editing, press “OK”. As shown below:

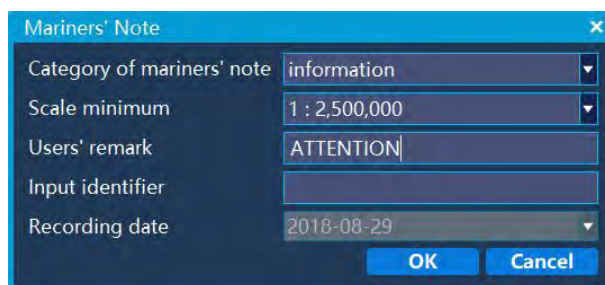

2.8 Mariners’ Note

The crew note menu can be used to enter navigational notes and warnings information by the crew during the voyage.

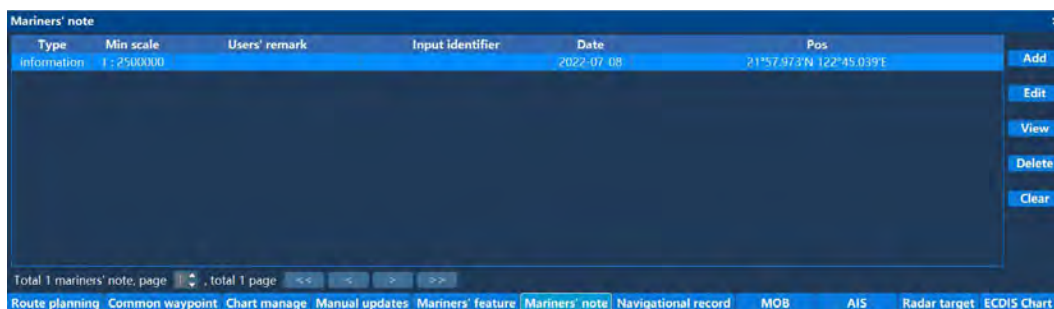

Note: When operating the Mariners’ feature, confirm whether the Mariners’ Note display is selected firstly. The operation is as follows: enter the setting, select “Mariner obj” in “Chart” and selected “Mariners’ Note”.

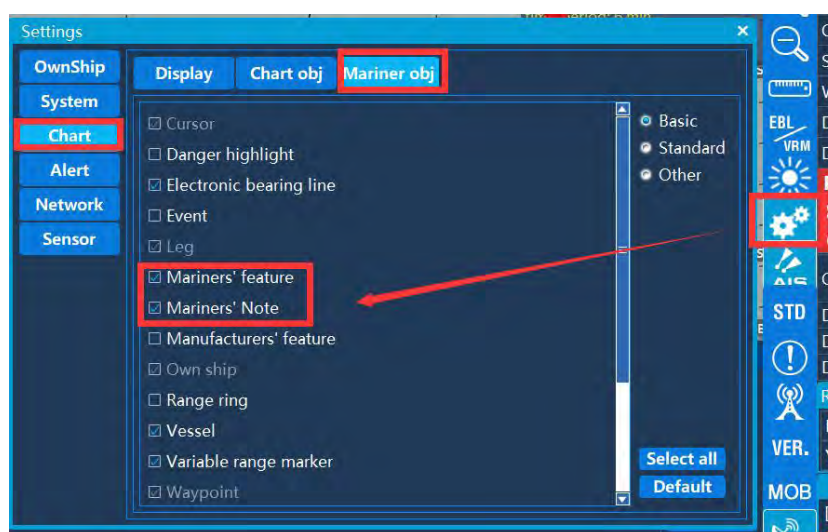

2.9 Navigation record

Click on the “navigational record” to bring up the navigation record list as shown below:

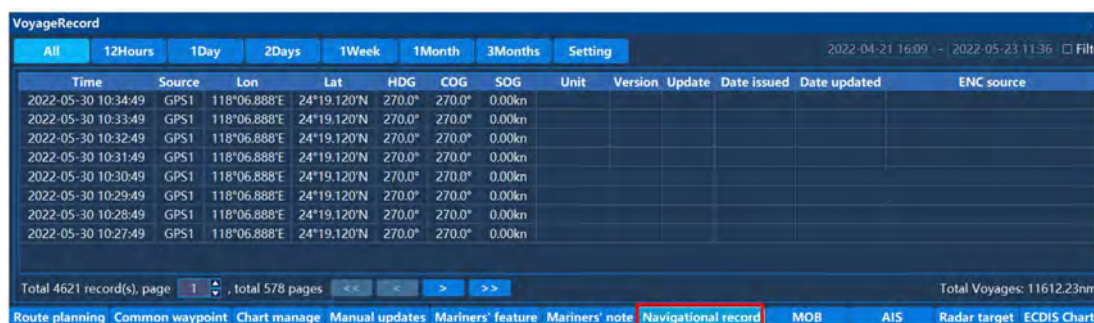

The navigational record includes the current navigational record for the 12 hours, 1 day, 2 days, 1 week, 1 month and the navigational record for the last 3 months.

Each record contains the recording time, location source, longitude, latitude, navigational heading, ship of heading, speed, unit, version number, update number, released date, updated date, and ENC source.

When selecting 12 hours/1 day/2 days/1 week sailing record, The default navigation log records one point every 1 minute;when selecting the last 1 month/3 months sailing record, The default navigation log records one point every 60 minutes;

Select one of records and double-click to preview the track. The chart would jump to the area where the track is located, we could zooms in and out to preview the track.

The total voyage of the selected voyage record can be automatically calculated and displayed.

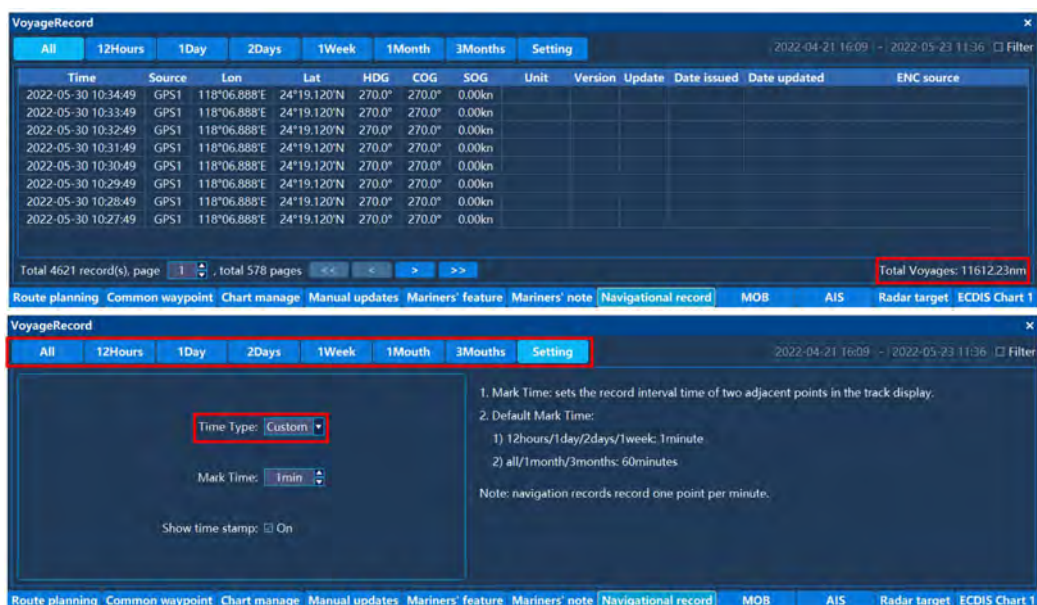

The time mark and display duration can be set in the navigation record, and the user can choose the track display range according to actual needs.

Time marker can set the interval time between the previous point and the back point in the track display.

After setting the display duration, the track record from the current time to the set duration (forward calculation) can be displayed.

Time stamp can be optionally displayed or closed.

2.10 AIS Information

Click “AIS” to bring up the AIS information list as shown below:

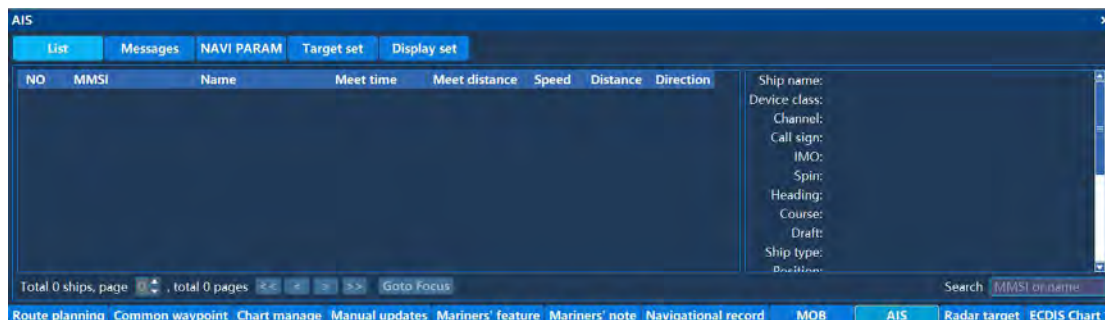

2.10.1 AIS List

The AIS information window consists of AIS list and AIS details.

The AIS list includes the number, MMSI, name (vessel name), distance from the vessel, speed, distance from the vessel, time of encounter, and distance met.

You can click the header of the MMSI, distance, and speedometer items to sort the list.

You can view the information by clicking "<<", "<", ">", ">>" below the panel or by entering the number of pages to be queried through the keyboard.

Select one of the list, the right information bar can be displayed the details of the AIS vessel including vessel name, equipment type, channel, call sign, IMO, spin rate, bow, heading, vessel type, draught, location, status, destination, estimated arrival Time, GPS antenna position, etc.

Double-click on the selected AIS vessel and the chart will jump to the location of the AIS vessel.

2.10.2 Messages

Send a short message to the specified MMSI number.

2.10.3 AIS navigation parameter settings

The AIS navigation parameter setting is an interface that can be updated to AIS navigation related data. This operation should be ensured that the AIS device is in two-way communication and the serial port is connected correctly.

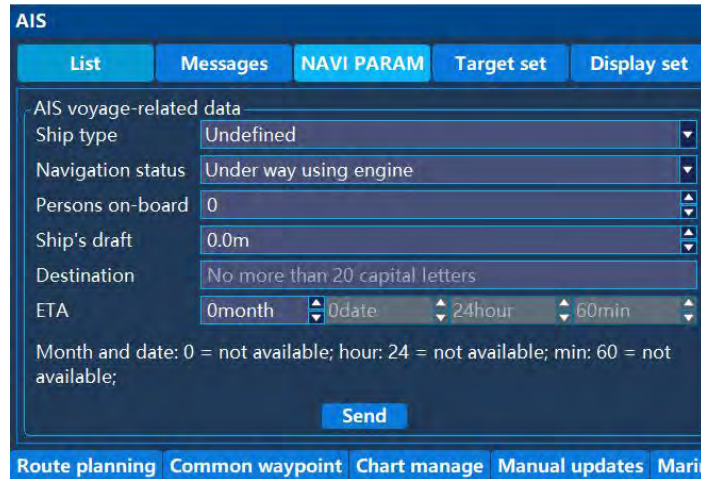

2.10.4 Target set



To set the AIS information. Set the activation of AIS target, includes Class A AIS and Class B AIS vessels.

AIS track settings includes hide track, class A, class B, display, and time can be set from 1 minute to 59 minutes. The specific parameters can be set according to the actual conditions.

CPA setting, the distance will be from 1nm-10nm. CPA time from 1 minute to 59 minute. The specific parameters can be set according to the actual conditions.

AIS lost alarm, alarms for active AIS and sleep AIS, the rang is from 1nm to 20nm. The specific parameters can be set according to the actual conditions.

Filter sleeping AIS targets and AIS data reports, you can selected the type of AIS target and set the filtering conditions. The specific parameters can be set according to the actual conditions.

2.10.5 Display set



To set the AIS display items, including own ship AIS icon, MMSI, ship name, navigation data, nationality, national flag, latitude and longitude, etc.

You can click the edit icon to set the ship color.

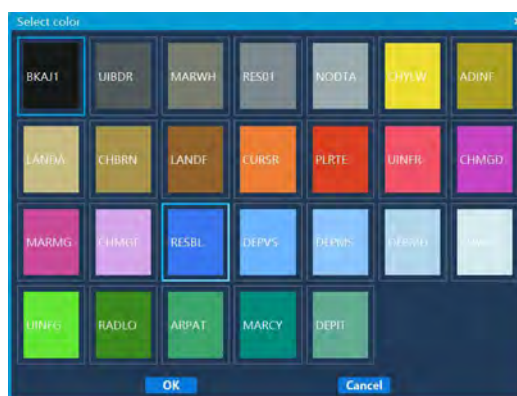

2.11 Radar target

Click on "Radar Target" to open the received radar target list information. As shown below:

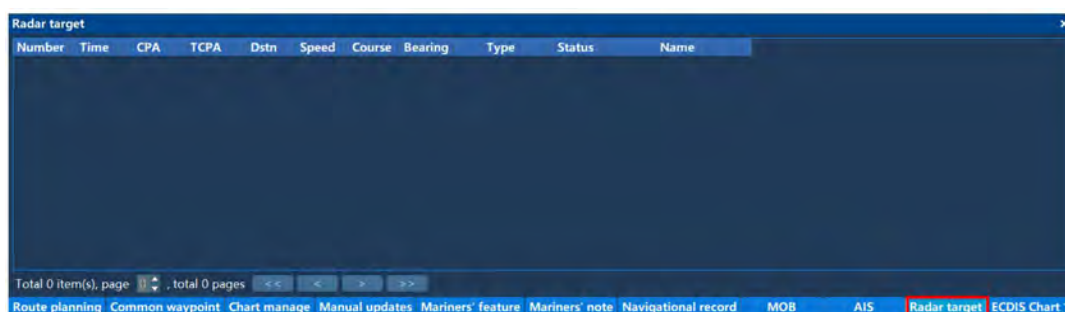

Display information about the received radar target, including radar number, time, CPA, TCPA, Distance, Speed, Course, Course type, Bearing, Bearing Type, Type, Status, Name, etc.

Double-click on one information of the list and the chart will jump to the location of the corresponding target.

Whether the radar icon is displayed on the chart or not can be set by the shortcut key. As shown below, after the radar display is turned on, all received radar icons and locations are displayed. Among them, when the radar button is lit, it indicates that the display is

turned on.



2.12 ECDIS chart 1

According to the symbols in ECDIS chart 1, it can be used to query the comparison of objects on the chart.

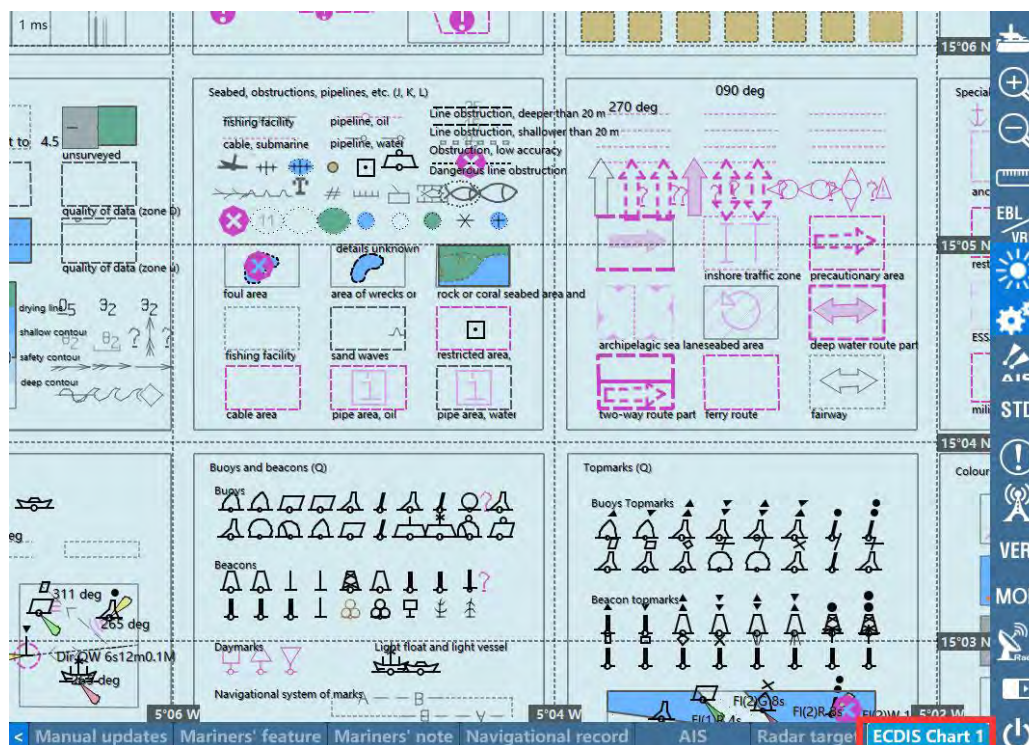

2.13 Settings

2.13.1 OwnShip setting

Click the Settings button on the right shortcut bar to pop up as shown below:

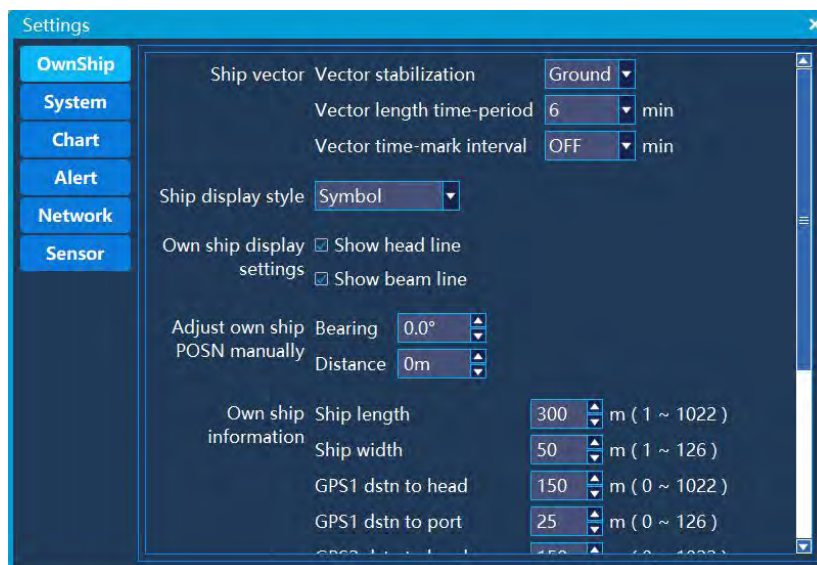

The ownship 's settings include ship vector, ship display style, own ship display settings, adjust ownship POSN manually, ownship information, initial position, etc.

The ship vector refers to the vector line of the ship 's motion. The setting items include vector stabilization, time period, and time mark interval.

The reference system includes ground and water. The ground is selected as the reference ground, and the water surface is selected as the reference surface. The time stamp period indicates that the position is reached after a few minutes by the current speed and heading, and OFF is selected to not display the vector line.

The time period interval indicates the tick mark of the vector line. When OFF is selected, it is not displayed. 1&6 indicates a small scale every 1 minute, and a large scale every 6 minutes. 6 means that one scale is displayed every 6 minutes. The display of the scale is limited by the reference frame and range.

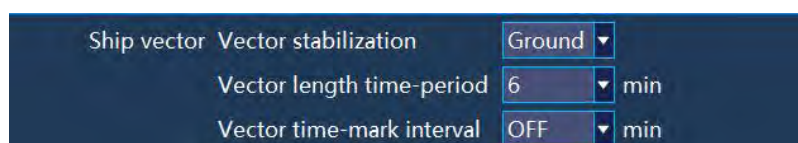

The ship display style refers to the style displayed by the vessel on the chart, and the symbol or the scaled outline can be selected. The scaled outline is displayed as a vessel type, and the size of the vessel type is displayed in proportion to the length of the vessel

and the width of the vessel. You can set the Settings in the ownship information. The ship length setting range is 1~1022m, and the ship width setting range is 2~50m. GPS dstn to head is the GPS installation position of the vessel, and this would be used as the starting point of the bow line. The range from GPS to vessel is 1~ vessel length, GPS dstn to head to port is 1~ vessel width. Anchor to CCRP ver dstn and Anchor to CCRP hor dstn, which can be used for the GPS positioning reference of the anchor. The ship display setting allows you to set whether to display the head line and the beam line. and checked means display.



Initial latitude and longitude



Manually adjust the position



2.13.2 System Settings

Click the Settings  button to enter the System Settings screen. System settings include unit, HDT, language, track, and north reference and other settings.

1) Unit settings including water depth, distance and speed units are set as shown:

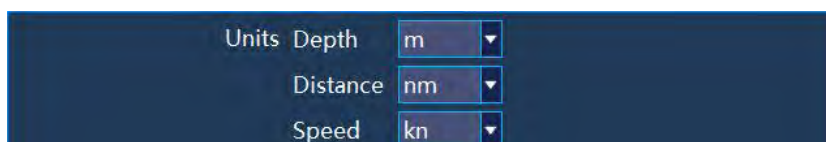

2) Choice of HDT:

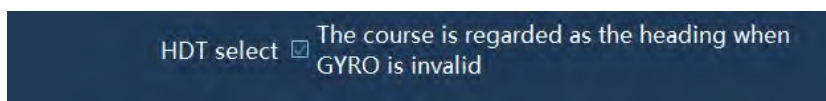

3) Dead reckon function turned on or off

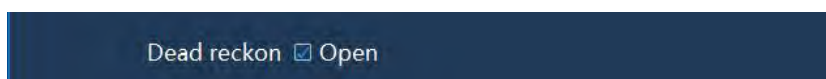

4) The language settings include Chinese and English as shown:



5) Cursor style selection is solid or hollow



6) North Reference Settings including True North and Magnetic north as shown:

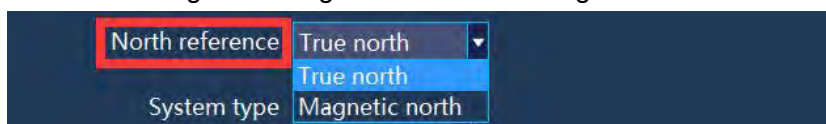

7) Set the system a host or a backup system



8) The Primary screen and volume, you can set the output to HDMI or VGA, and adjust the volume output size.



9) When the vessel is in the state of navigation detection, the distance between the vessel icon and the edge of the screen can be set as shown:

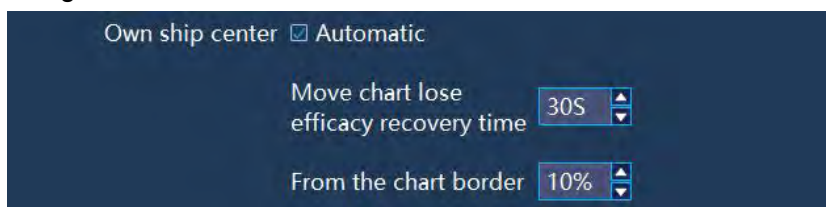

10) System time calibration settings, you need to click OK after modifying the values, as shown:



11) Save the user's setting parameters, the user's personalized settings.

This function is to satisfy different users to save the different parameter settings of the

system.

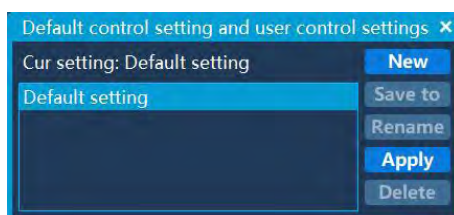

12) Data backup, applied to the backup system.



13) All settings are restored to the factory settings and user data is not deleted. Create the user settings, click "Apply", a confirmation window will be popped up, click Yes for confirmation.

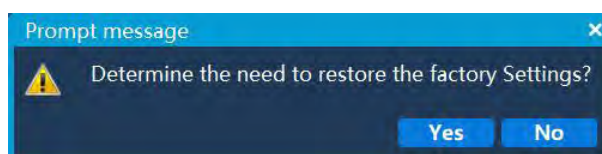

2.13.3 Chart setting

The user can click the setting button and select the chart setting to make the relevant chart settings according to the navigation needs. As figure:

Click on the drop-down list to bring up the image:

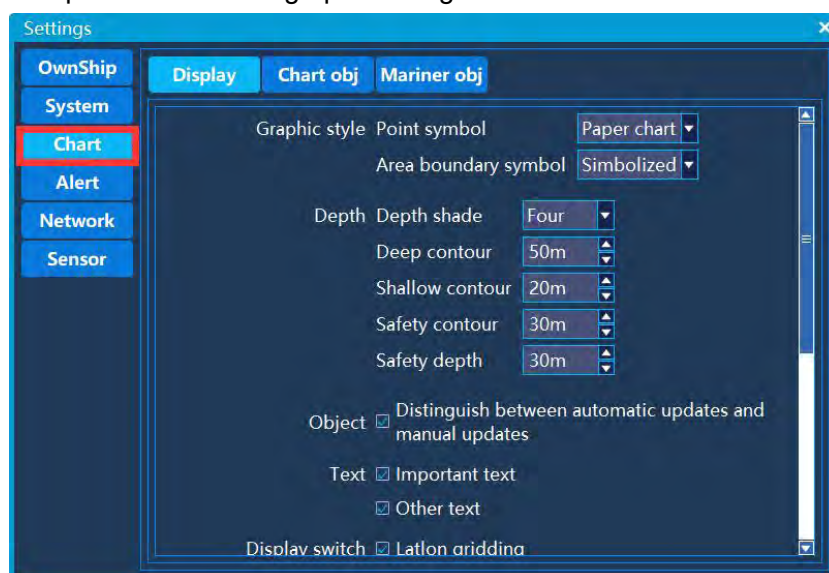

Point symbols: Includes simple symbols and traditional paper symbols.

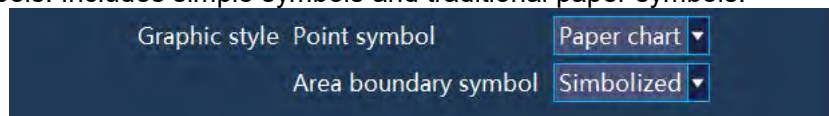

Depth shade: Includes two or four. You can set the contour line:

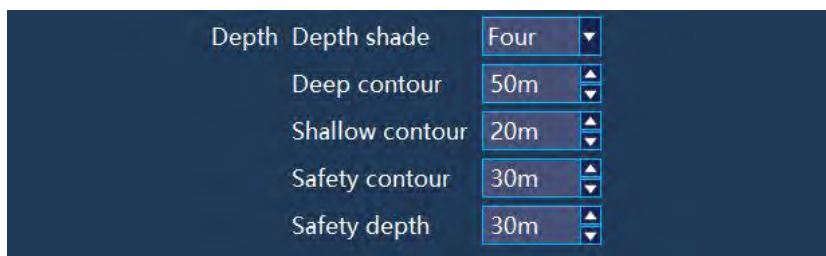

Safety contour: You can set the shallow water contour in 0-9999m. The area smaller than the value set by the safety contour will be marked with a color different from other contour.

Shallow contour: You can set the shallow water in 0-9999m. The area smaller than the value set by the shallow water contour will be marked with a color different from other contour.

Deep contour: You can set the deep water contour in 0-9999m. The area larger than the value set by the deep water contour will use the color different from other contour.

Safety and other depth values: You can set the safety depth value from 0-9999m, the default is 30m. When the safe water depth in the area where the vessel located is lower than the value set by the safety depth value, the system will automatically alarm to remind the driver.

Text: Set the content of the text display.

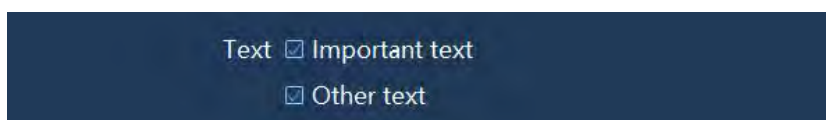

Color scheme: including day, dusk, night. Click on the drop-down list to bring up the selection:

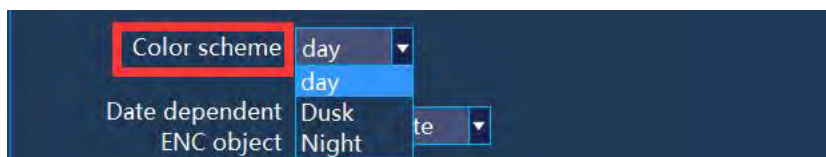

The UI interface font color will be adjusted according to the color scheme selected . As shown below:

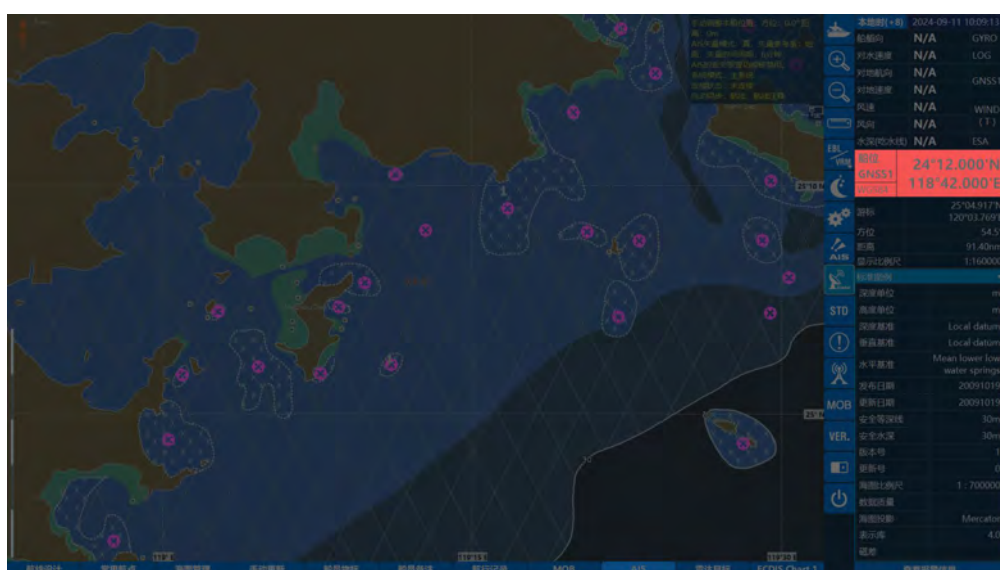
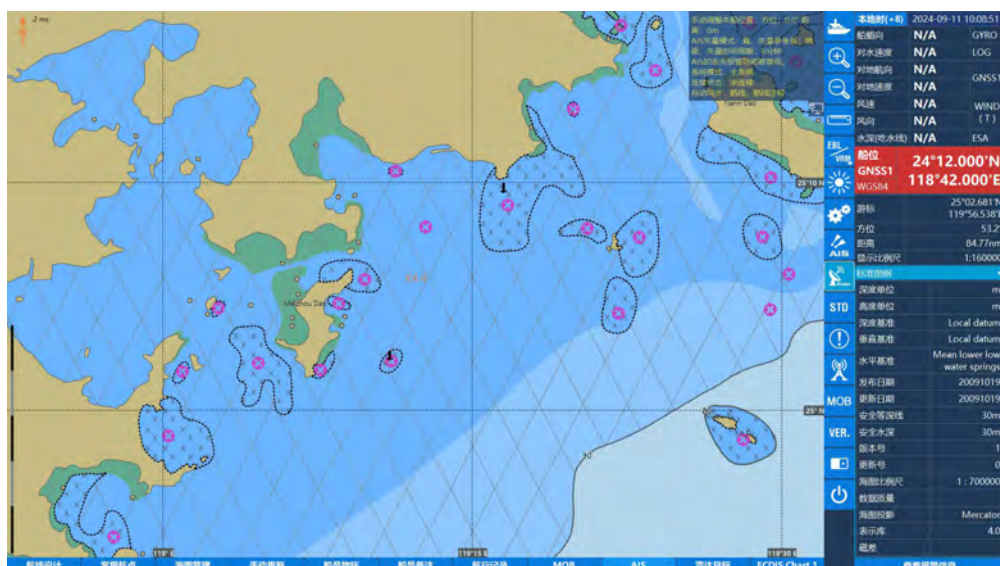

Map language: Set the language of the map, including national language and English.

Click on the drop-down list to bring up the selection:

Language National language ▼

Select the national language, and the place names on the map are displayed in Chinese. Select English language, and the place names on the map are displayed in English.

Position quality: displays the position accuracy symbol, and the question mark indicates that the object on the chart has insufficient geographic accuracy.

Light sector lines: The scalloped fan line length of the beacon, when selected, the beacon would show the actual range by equal proportion, when unselected, the beacon would show the range with a fixed length.

Latlon gridding: Control the warp and weft grid display or not. When selected, the chart shows the warp and weft grid and the corresponding latitude and longitude coordinates.

Shallow water highlighting: Highlight the shallow water area when hooking as shown below:

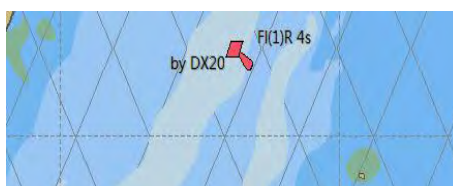

Less detail in a small scale: When hooking, some objects will not be displayed on the chart.

Graphical Index: Enables the display of the map border to be turned off. When it is selected, the map border is displayed. You can see the overlay of the map block displayed on the current screen through the map border.

The chart objects are as follows:

Basic display: The basic display of the chart includes the coastline (at high tide), the vessel's safety and other deep lines, the display scale, and the north arrow.

Standard display: including basic display, buoy, beacon, other navigation aids, no-sail zone, restricted navigation zone, etc. The default is standard display.

Other display: The user can select the display according to the navigation needs of the information class on the chart. When you want to add or delete information, the information would be added or deleted by class. For example, the water depth is not displayed on the chart, if you want to display the water depth, you should select the water depth and click

the left mouse button and then you can see the water depth display on the chart. And when you click the left mouse button again, you can see that the water depth on the chart is no longer displayed. You can add or delete other information classes as above. As the following picture:

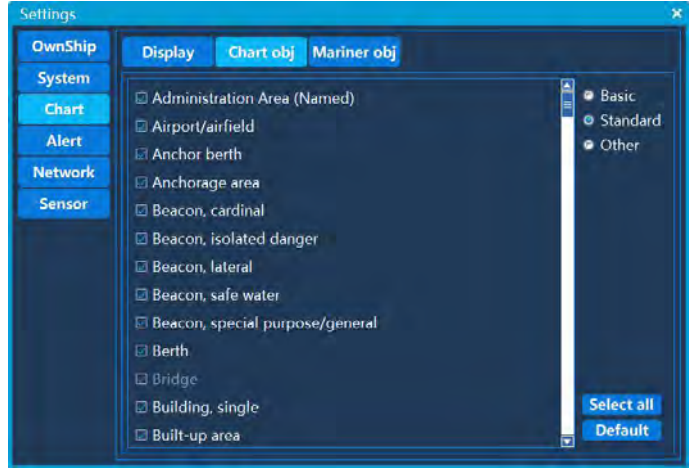

The mariner object display shows:

You can set the display according to the requirements of the mariner object, and the mariner object can be set separately in different display modes. If you need to manually operate the mariners' feature and mariners' notes, you need to select the mariners' feature. As the picture shows:

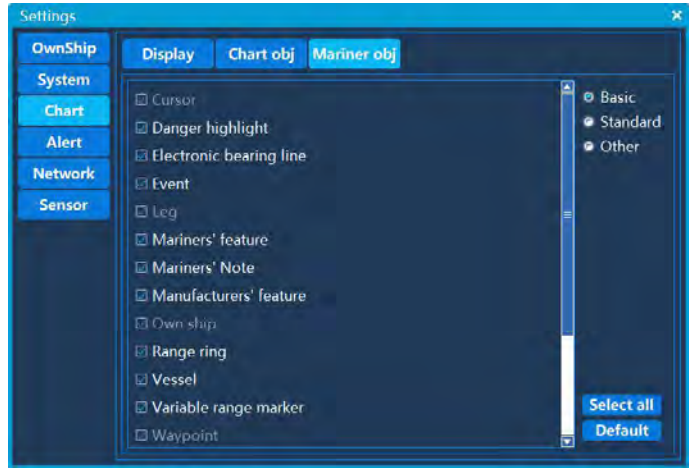

2.13.4 Sensor Settings

Sensor settings include GPS, AIS, compass, depth sounder, log, serial port, baud rate and master settings. Each input signal type is connected according to the corresponding port. After setting, click the "Apply" button to set the parameters to take effect. As Figure: First Model:

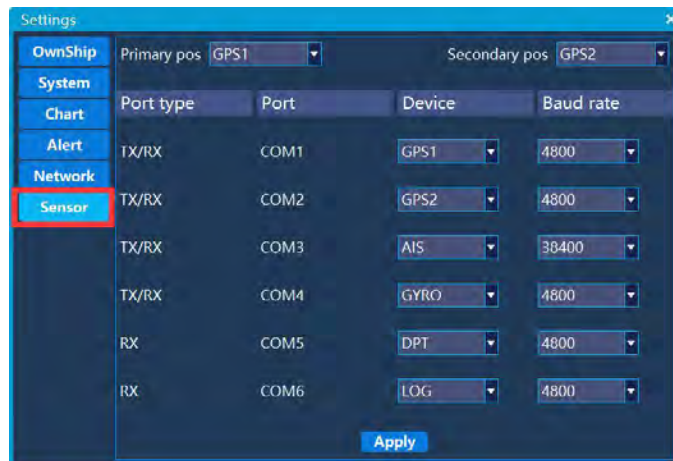

Second Model:



The baud rate can be set independently for each port. You can select the signal baud rate corresponding to the external connection line:



2.13.5 Alarm Settings

The alarm setting includes navigation monitoring alarm, AIS encounter alarm setting, special condition area alarm setting

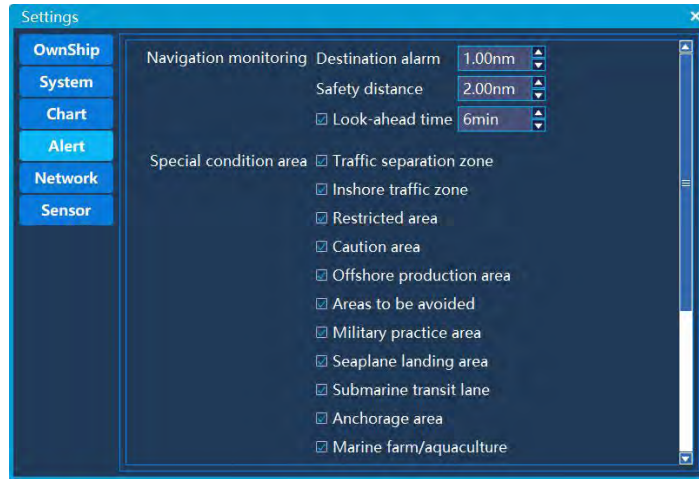

Navigation monitoring alarms include destination alarms, route offsets, and safe distance and look-ahead time. As Figure:

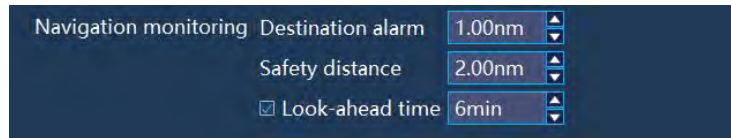

The destination alarm indicates that when you are sailing, the distance between the position of the vessel and a dangerous object or a dangerous area is less than the setting value, it would be alarmed..

The safety distance indicates that the yaw alarm is effective, when the distance between the position of the vessel and the route is more than the value of the set route offset, the yaw alarm would be alarmed

The Look-ahead time indicates that the look-ahead time alarm is effective, when the value of look-ahead time less than the time of arriving to the yaw or the object limit, it would be alarmed.

When the vessel is approaching a special condition area during the voyage., it would be alarmed. Special condition area containing as following:

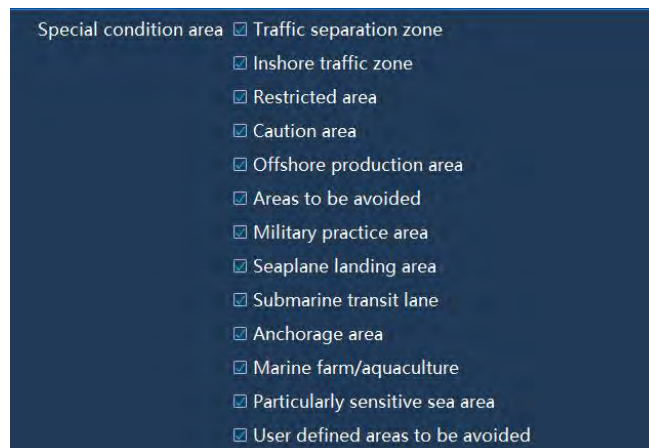

You can select the alarmed area according to the navigation needs, and the alarm will be automatically alarmed when the vessel approaches the selected area.

Alarm priority:

The alarm priority is setting the priority of the alarm.

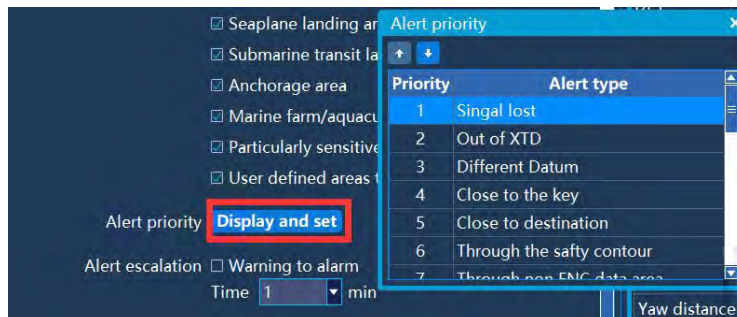

Alert escalation:

The alert escalation is setting to change the warning to alarming. After setting time, the warming will be upgraded to an alarm and the alarm status bar will change.

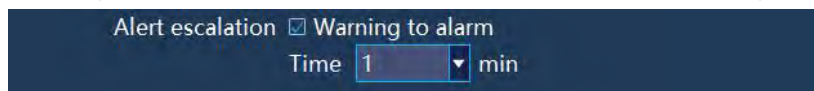

Dragging alarm:

After the dragging alarm is turned on, the vessel 's current position coordinates would be used as the center point. When the current position of the vessel is more than the value of the distance, it would be alarmed.



2.13.6 Network Settings

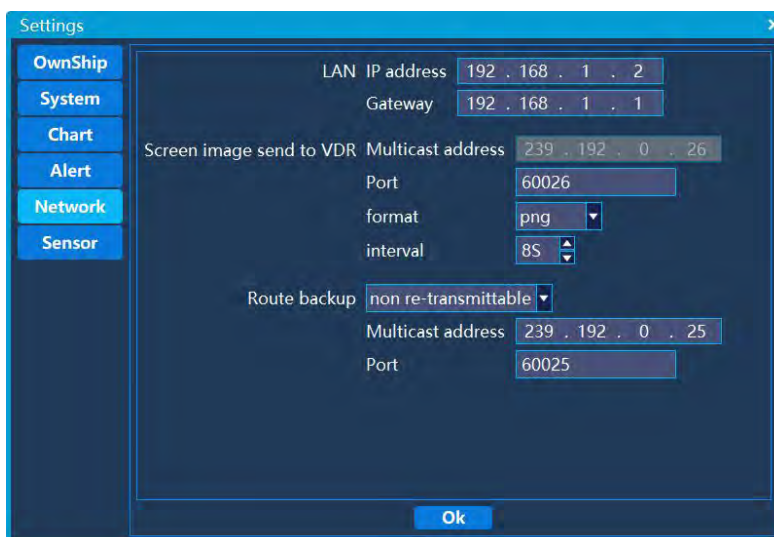

Access the VDR network interface. You can set the IP address according to the network segment.



The following two columns can remain the same as the system and you do not need to change it. If you need to match the VDR, you can change the multicast address and port number to match the VDR. The VDR transmission picture format is divided into PNG and JPG formats, and the time interval can be set from 1 second to 15 seconds.

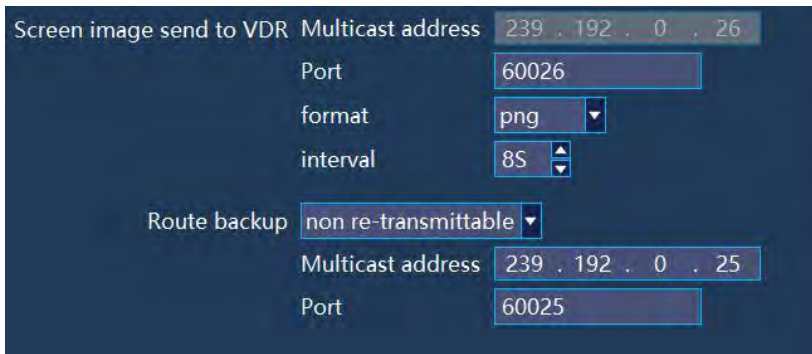

2. 14 Alarm

2.14.1 Overview

During the route monitoring process, ECDIS will automatically issue a yaw alarm when the distance between the position of the vessel and the route is more than the value of the set route offset.

During the route monitoring process, ECDIS will automatically alarm that the vessel close to the critical point when the key point on the route is less than the value set by the user.

After accessing the AIS, the AIS will issue an AIS alarm when the AIS close to setting time and distance.

ECDIS automatically issues a sensor signal loss alarm when the connected sensor signal is lost.

ECDIS automatically issues different reference alarms when the reference system of the positioning system is different from the reference used by the chart.

ECDIS automatically issues an alarm near the special area when it is close to the prohibited area or a geographical area with special conditions.

ECDIS automatically issues a safety deep contour warning when crossing the vessel 's safety contour in advance observation time.

Anchor alarm.

2.14.2 Alarm prompts and responses

After the alarm occurs, the alarm information will be displayed at the alarm prompt and flash, and an alarm sound will be sounded. The alarm prompt window is as shown:

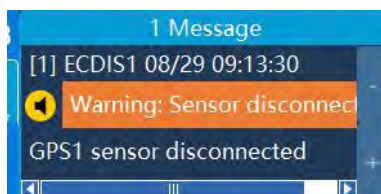

The alarm includes the alarm time, the type of alarm, and the content of the alarm.

If the user does not need the alarm sound, you can select the silence.

When there are many alarms, you can view the alarm contents of the next and previous ones by cursor operation + and - buttons.

When you click the confirmation button, the alarm will be invalid until the alarm condition is released, and the alarm would be valid again when the alarm re-triggered to re-alert again.

When you click Confirm All to confirm that all current alarms are confirmed.

When the alarm is all confirmed or the alarm is not generated, the +, -, confirmation, and all confirmation buttons cannot be clicked.

2.14.3 Alarm Record

The alarm related information will be recorded in the alarm record after the alarm occurs.

The record contains number, icon, occur time, alarm type, alarm content, response time, end time, etc., as shown in the figure:

The image shows a window titled "Alarm record" containing a table with the following data:

No.	Icon	Occur time	Alarm type	Alarm content	Acknow
001	🟡	2018-08-29 10:00:00	Singal lost	GPS1 signal lost	
002	🟡	2018-08-29 09:59:48	Sensor disconnected	GPS1 sensor disconnected	
003	🟡	2018-08-29 09:58:47	Sensor disconnected	GPS1 sensor disconnected	
004	🟡	2018-08-29 09:57:48	Singal lost	GPS1 signal lost	
005	🟡	2018-08-29 09:13:30	Sensor disconnected	GPS1 sensor disconnected	
006	🟡	2018-08-29 08:37:54	Sensor disconnected	GPS1 sensor disconnected	
007	🔴	2018-08-29 08:34:18	Out of XTD	Cross Track Distance(XTD) exceeds the set limit(0.10n...	

The table is part of a larger interface with various navigation and function icons on the right side, including a red-bordered warning icon.

The alarm record can store the most recent 1000 alarms, and the system will automatically maintain these alarms.

When the user acknowledges the alarm, the response time of the corresponding alarm will be updated.

When the alarm occurs for a period of time, the system will detect that the end time will be updated when the current alarm is released. If the alarm in the prompt box is not confirmed, the alarm will be removed from the prompt box.

2. 15 LOP positioning

2.15.1 Overview

When the GPS fails, the LOP positioning function can be used to calculate the position of the vessel . The positioning line is based on azimuth (azimuth positioning line) and range based (range positioning line). Two or more positioning lines can locate the vessel , and the two positioning lines can be mixed.

You can set the positioning lines up to six. If more than 3 positioning lines are set, you need to manually select 2 to 3 for positioning.

2.15.2 How to use

The following describes the use of two azimuth positioning lines to determine the position of the vessel .

1.The multi-function window selection displays the LOP positioning window as shown:

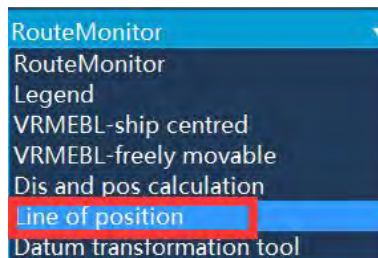

2.Left mouse click on the chart to select the position of the observation point or manually input the latitude and longitude at the latitude and longitude of the window;

3.The type of azimuth is selected in the Type box, the input azimuth (the azimuth of the vessel to the observation point) and the range (maximum 120 nm), the initial azimuth value is 0 degrees, and the range is 2 nm. The range is the length of the azimuth line. If the type is selected as the range, it means the radius of the range bearing line, as shown:



4. Enter the time;

5. click **Set LOP**, set the first azimuth positioning line. At this time, the bearing line becomes a solid line, the observation point becomes a real point, and the setting time (hours) is displayed in the middle of the line segment, as shown in the figure:



6. Repeat steps 2, 3, 4, and 5 to set the second positioning line (up to 6). If the input time is later than all previous positioning lines, the current direction and speed will be used. The time-observed positioning line is converted to the position of the last positioning line, and the positioning line observed in the same situation is as shown:

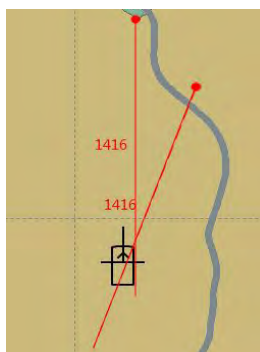

7. click **Select Cross Point** bring up the Select Cross Point window as shown. The list in the window shows all the intersection positions. On the chart, the selected intersection points are drawn with big circles, and the positioning line becomes selected.

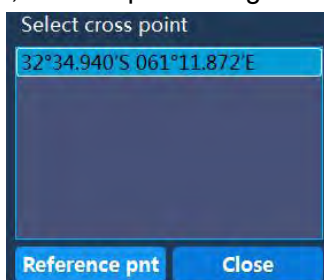

8. click **Reference pnt**, set the reference point location and properties, as shown in

Figure :

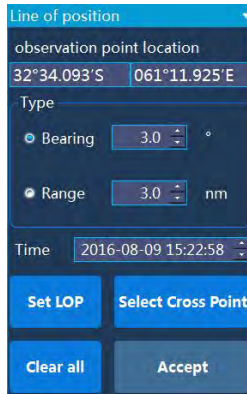

Location: Location of the intersection, which can be modified;

Sensors: Empty, GPS (G), DGPS (dG), Decca (D), Loran (L), Radar (R), Astronomical (A), MFDF (M), Transit (T), GNSS (GNSS), Line Of position (LOP), Visual Bearing LOP's (V), Visual/Range LOP's (VR), showing shorthand under the icon;

Time: The icon is displayed directly above (only the hour and minute are displayed);

OK: Close the location property window, the intersection icon is as shown, the positioning line becomes unselected;

Cancel: Close the position property window, the chart does not plot the intersection icon, and the positioning line becomes unselected;

Application: The location property window is not closed, and the intersection icon is as shown in the figure;

9. click **Apply**, If during the estimation operation, the plot type changes from EP to DR, and the plot position is updated as the position to generate a log.

2.16 Distance and position calculation

2.16.1 Distance calculation

The distance and position calculation window is located in the multi-function window, as shown in the figure **DegDis** and is not selected at this time to calculate the azimuth and distance of the two position points. Enter the starting point and ending position, click the calculation button, the orientation and distance of the constant line RL and the big circle route GC will be calculated.

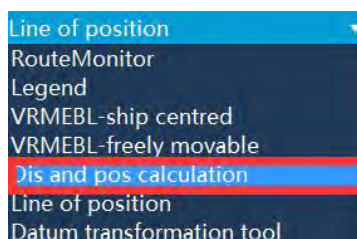

2.16.2 Position calculation

As shown in the figure, select **Dis and pos calculation**, enter the starting point position, azimuth and distance, click the calculation button, the position will be calculated according to the horizontal line and the big circle route.

 A screenshot of a dialog box titled 'Dis and pos calculation'. It has a dark blue background with white text. The fields are: 'Start pos' with coordinates '32°32.033' S' and '061°02.905' E'; 'End pos' with the same coordinates; two input fields for '0.0 °' and '0.00 nm'; a checkbox for 'DegDis' which is unchecked; and a blue 'Calculate' button.

2.17 Standard Legend

The standard legend information is displayed in the Multi-Window Standard Legend panel, which indicates information about the current use of the chart. All the legend information is as shown:

Legend	
Depth Units	m
Height Units	m
Sounding Datum	Lowest astronomical tide
Vertical Datum	Mean high water springs
Horizontal Datum	Mean lower low water springs
Edition Date	20010409
Update Date	20010409
Safety Contour	30m
Safety Depth	30m
Version Num	2
Update Num	0
Chart scale	1 : 52000
Quality of data	zone of confidence B
Projection	Mercator
Presentation lib	3.4
Var	35.92°W 1996(7°W)

Depth unit: Displays the water depth unit set in the system settings.

Height unit: Displays the water depth unit set in the system settings.

Water depth reference: The depth starting point in ocean measurements.

Vertical datum: The starting point of the land elevation.

Horizontal reference: The horizontal reference plane, usually WGS-84.

Release Date: Displays the release date of the vessel 's frame.

Update Date: Displays the update date of the vessel 's frame.

Safety isobath: Displays the value of the safety contour setting in the chart settings.

Safe Water Depth: Displays the value of the safe water depth setting in the chart setting.

Version number: Displays the version number of the map where the vessel is located.

Update No.: Displays the update number of the map where the vessel is located.

Chart scale: The maximum chart scale for the map where the vessel is located.

Data Quality: Displays the data quality of the map in which the vessel is located.

Chart projection: Shows how the chart is projected.

Representation library: A representation library showing the frame where the vessel is located.

Magnetic Difference: Displays the magnetic declination of the position of the vessel .

Chapter 3

Chart Installation

This chapter will guide you to be gradually familiar with chart installation.



3.1 Summary

Click “Chart manage ([management](#))”, and the chart list will pop up, as shown in Fig 3-1. The chart management is made up of chart number, range of longitude, range of latitude, scale and chart information. Chart information that can be displayed includes chart number, scale, the minimum latitude, the minimum longitude, the maximum latitude, the maximum longitude, version number, date of publication, update number, update date, manufacturer and way of arrangement and so on.

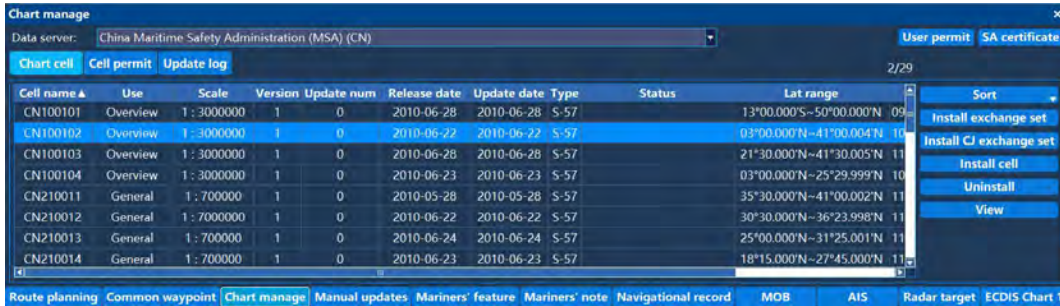

3.2 View Chart Information

Current chosen chart can be modified by pressing up and down buttons or pressing the left mouse button. Related information of the current chosen chart is displayed in the chart information column. If a chart to be viewed is not on current display, the user can press up and down buttons or roll up/down the right scroll bar until the chart information to be viewed is found.

3.3 Chart Sequencing

Click the Sort button to choose to sort by unit name, scale, date of discovery, etc.

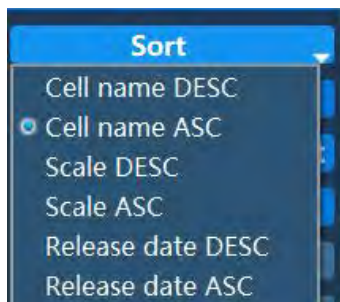

3.4 IHO S-63 Data Protection Solution

Xinuo ECDIS is compatible with IHO S-63 data protection solution (Version 1.2), with forward compatibility with Version 1.1.

3.5 SA Certificate

As a manager of S-63 data protection solution, International Hydrographic Organization (IHO) provides self-signed SA certificate (in X509 format) for verifying if S-63 data packets of electronic charts come from data service providers of electronic charts authorized by IHO.

SA certificate is generally named IHO.CRT. You can download an SA certificate from the official website of IHO:

www.iho.int → Home → Publications → Download List → S-63 → S-63 SA Certificate

Some data service providers of electronic charts may include the SA certificate in the released root directory of S-63 data packets of electronic charts (e.g. D:\IHO.CRT). You can also install such SA certificate. However, you are strongly recommended to download it from the official website of IHO and install it, in order to make sure that the SA certificate isn't fake.

The latest SA certificate has been installed on Xinuo ECDIS when it is released from the factory. You can view detailed information of the SA certificate in its dialog box, or you can log onto the official website of IHO to download and install the updated SA certificate by yourself.

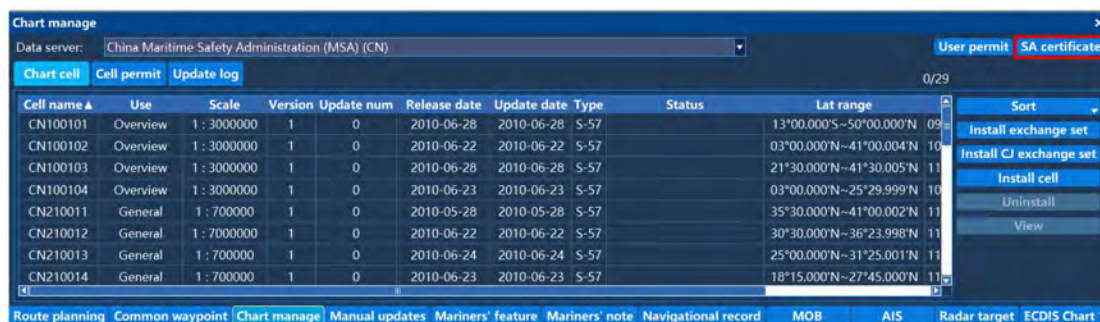

3.5.1 Installation of SA Certificate

- Click “install certificate” and open the file dialog box. Only the certificates named as IHO.CRT can be displayed in the file dialog box.
- Choose the SA certificate you need to install and click “open”.
- If the SA certificate valid, the installation will be successful without any prompt.
- If the SA certificate is invalid, you will get following prompts: **“SSE 06 - this SA certificate (public key) is invalid. IHO would have updated the SA certificate, and please acquire a new one from the official website of IHO.”**
- After installing the SA certificate, you can view detailed information of the

certificate in its dialog box, including issuer, date, expiry date and signature algorithm.

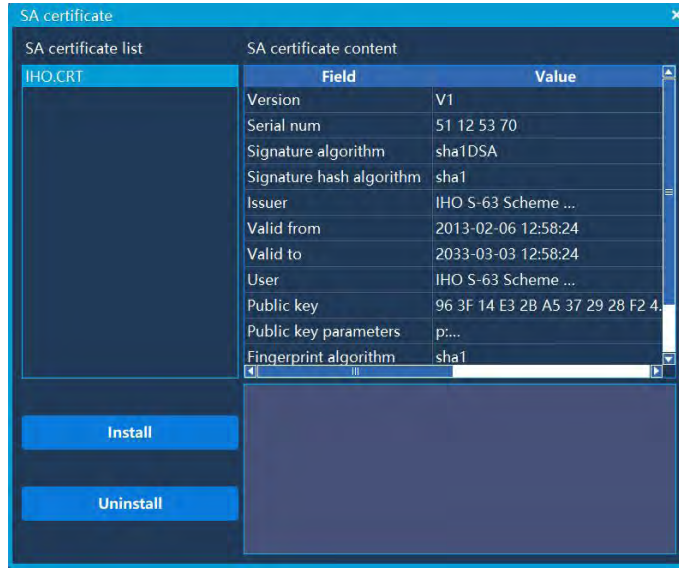

3.5.2 Uninstall SA Certificate

- Click “uninstall certificate”, you will be reminded as follows: **“Are you sure to uninstall the SA certificate?”** If you click “Yes”, the SA certificate will be uninstalled from the system. You can click “No” to not to uninstall the certificate.

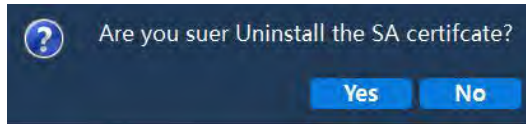

- After the SA certificate is uninstalled, no detailed information will be displayed.

3.6 User permit

As an identity marker of **ECDIS (Electronic Chart Display and Information System) and ECS (Electronic Chart System)**, user permit can ensure that the ECDIS/ECS produced by each manufacturer only has a sole identity marker on a global basis. It is a hexadecimal text composed by a group of 28 characters. Users can copy the user permit and submit it to a data service provider to buy licenses of electronic charts. The data service providers submit user permits through users, to generate corresponding S-63 data packets of electronic charts. This mechanism can make sure that purchased data packets of electronic charts can't be used by other ECDIS/ECS.

3.6.1 Generate User Permit

- Click “user permit” and open the dialog of user permit. This dialog displays a hexadecimal user permit with 28 characters. You can record it and use it for buying licenses of electronic charts from data service providers of these charts.

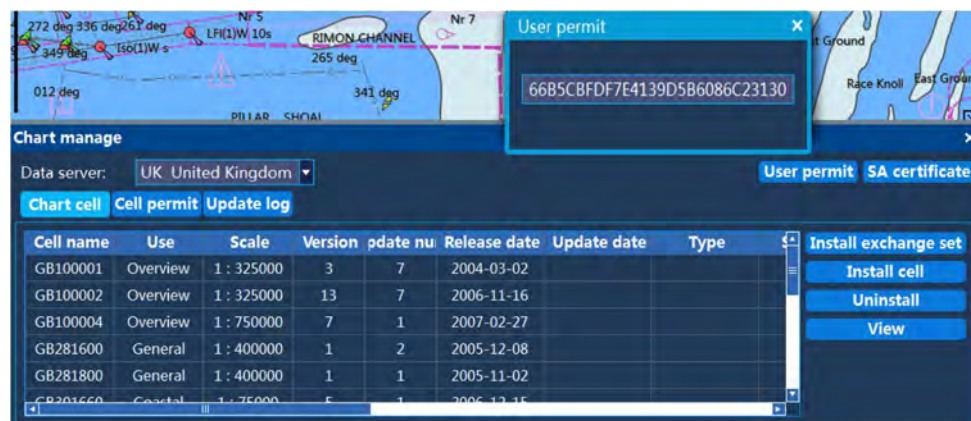

3.7 Data Service Providers

Xinuo ECDIS supports the simultaneous management of electronic chart exchange sets from multiple data service providers. Cell permit and product catalogue are classified according to data service providers, because following dialog boxes and pages exist for all electronic chart service providers:

- Chart cell
- Cell permit
- Update log

3.8 Cell permit

After you submit a user permit to a data service provider to apply for purchasing license of an electronic charts, the service provider will issue the cell permit (license of electronic charts) and S-63 data packet of electronic charts (including basic packets and updated packets). The cell permit can be used for decrypting and installing the S-63 electronic charts you have ordered. If you order electronic charts from multiple data service providers, you will receive several cell permits. This means these cell permits shall be separately installed.

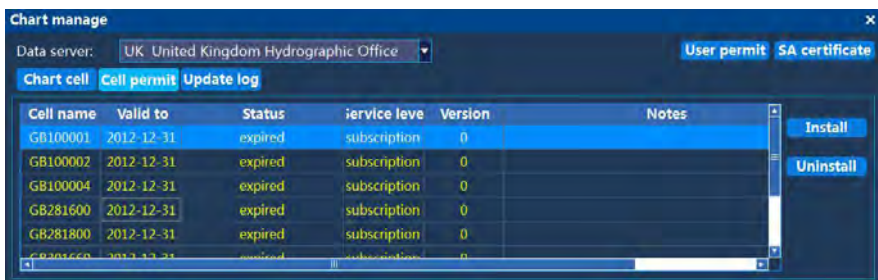

3.8.1 Install Cell Permit

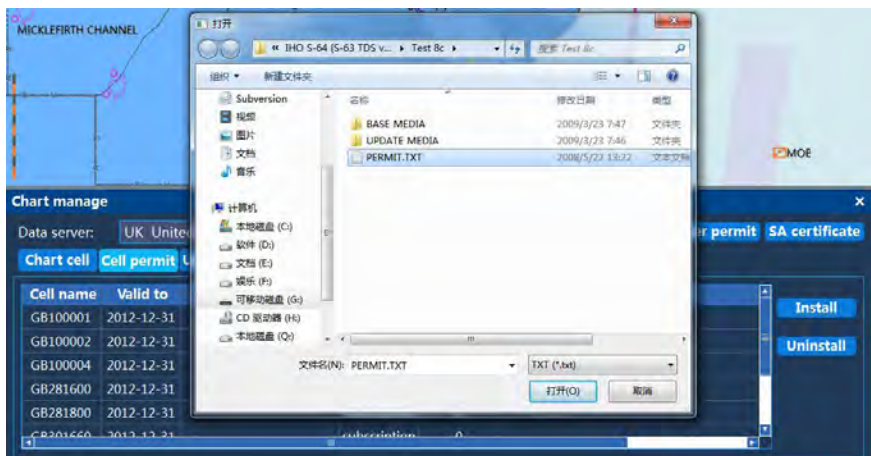

- Click “Install” and open the file dialog box. Choose the cell permit document named PERMIT.TXT and open it.
- If the format of a cell permit document is wrong, you will get following prompt: **“SSE 12- the format of cell permit is wrong.”** Click “Yes”, and the installation is completed.
- If the CRC of cell permit is invalid, perhaps the cell permit is not ordered by you, or the document is damaged. Then, you will be reminded as follows: **“SSE 13- CRC of cell permit is invalid.”** Click “Yes”, and the installation is completed.
- If any cell permit expires, you will be reminded as follows: **“SSE 15 - the permit you’ve subscribed has expired. Please contact your data service provider to renew the permit.”** After you click “Yes”, this prompt will not be given over again, and the installation will continue. The expired cell permit is still installed on the system, but following alarm will be given if any electronic chart with any expired SA cell permit is displayed later: **“SSE 25- the [CN302307] license of electronic charts has expired, so please don’t use it for navigation.”**
- If any cell permit can just remain valid for less than 30 days, you will be reminded as follows: **“SSE 20- the license you have subscribed will remain valid for less than 30 days. Please promptly contact your data service provider to renew your license.”** Once you click “Yes”, this prompt won’t be given later, and the installation will continue.

- After the installation, an installation report of a cell permit will be given. You can check the state of all cell permits in the list, including expiry, remaining valid for less than 30 days, validity.
- You can return to the dialog box of electronic charts to view installed cell permits in the page of cell permits.

3.8.2 Uninstall Cell Permit

- Open the page of data service provider and switch to the page of cell permit.
- Choose a cell permit to be installed and click “uninstall”. Then, you will get a prompt: “**Are you sure to uninstall the cell permit?**” If you click “Yes”, the cell permit will be uninstalled from the system. You can choose not to uninstall it by clicking “No”.

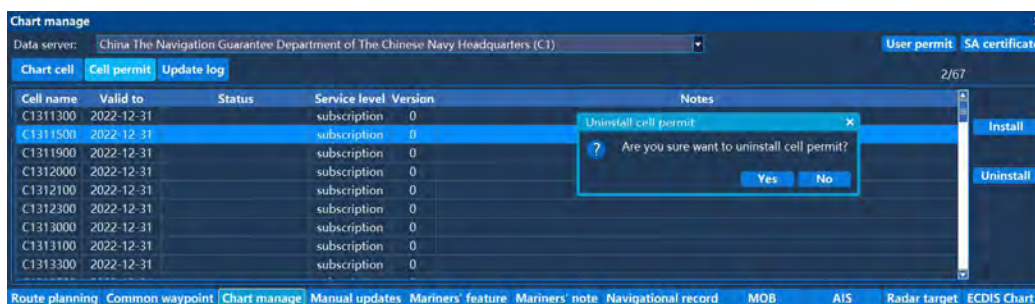

- Once all cell permits are uninstalled, it will be displayed empty on the page of cell permits.

3.9 Electronic Chart Cells

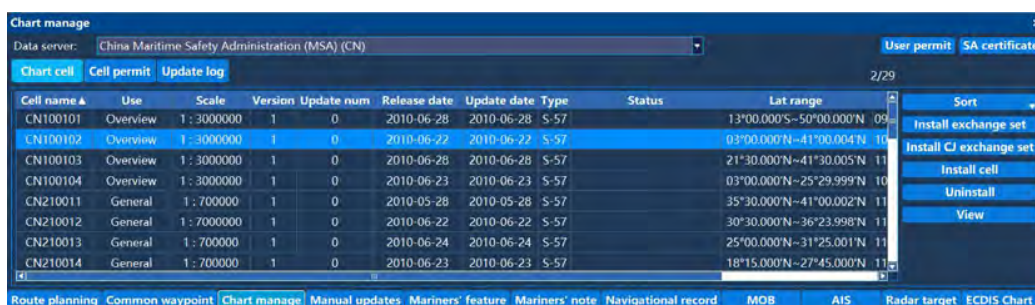

The dialog box of electronic chart cells displays the chart cells that have been installed on current system. You can view the general information of each electronic chart cell on this dialog.

- If updated or not (Indicated by an exclamation mark!)
- The dialog box of electronic chart cells will be compared with installed product catalogue. If there is any updated version of electronic chart cell, a prompt will be given in the first column of the record and indicated by an exclamation mark (!).
- Cell name (e.g. **CN302307**)
- Date of issue (YYYYMMDD)

- Version number
- Update date (YYYYMMDD)
- Update number
- Type (S-63 or S-57)
- State (expired, canceled, permitted, remain valid for less than 30 days)
- These words are only effective for S-63 electronic chart cells. For S-57 electronic chart cells, these words won't exist. There are several states as follows:

1) Expired: A cell permit corresponding to an electronic chart cell has expired and become unsuitable for navigation. In browsing this electronic chart cell, the system will give a prompt.

2) Canceled: An electronic chart cell has been canceled, not to be maintained any longer and become unsuitable for navigation. In browsing this electronic chart cell, the system will give a prompt.

3) Remain valid for less than 30 days: If the cell permit corresponding to an electronic chart cell will remain valid for less than 30 days, please promptly renew the license of the electronic chart. A prompt will be given when this electronic chart cell is browsed.

4) Licensed, for S-63 electronic chart cell with a cell permit that can be valid for over 30 days.

3.9.1 Install Exchange Set

The installation guide is used for installing data packets of electronic charts with S-63 catalog structure specified by IHO. For this catalog structure, please refer to the S-63 data protection solution. S-63 data packets of electronic charts can be only installed through the installation guide. Meanwhile, the installation guide is compatible with S-57 data packets of electronic charts with S-63 catalogue structure.

- Click “install exchange set” and open the window for such installation.
- Choose the root directory of data packets of electronic charts.

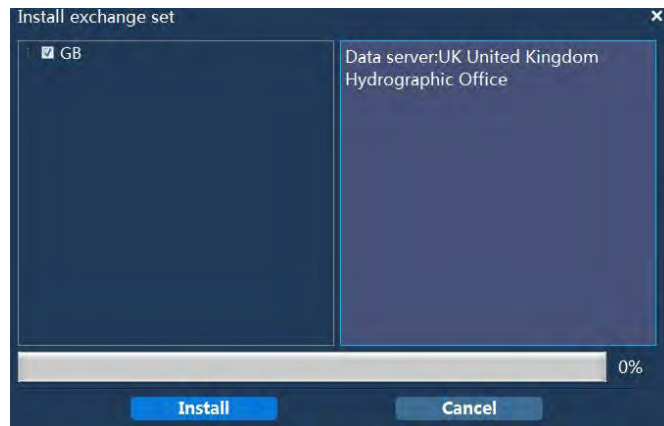

- Click “Install” to start the installation. Then, the system will execute following operations:

1. Check the SA certificate

1) If SA certificate hasn't been installed, following prompt will be given: **“SSE 05-SA digital certificate (X509) is unavailable, and you can get the certificate from the official website of IHO or your data service provider.”** Click “Yes”, and the installation is completed.

2) If the certificate or public key of the SA certificate is wrong, you will get following prompt: **“The format of SSE 08 - SA digital certificate (X509) is wrong. You can get the right one from the official website of IHO or your data service provider.”** Click “Yes”, and the installation is completed.

3) If the SA certificate has expired, you will get the following prompt: **“SSE 22 - SA digital certificate (X509) has expired. You can get a new one from the official website of IHO or your data service provider. You can also get a new SA public key from the official website of IHO or your data service provider.”** Click “Yes”, and the installation is completed.

2. Verify SA-signed Data Service Certificate (Signed Certificate for Electronic Chart Unit)

For each electronic chart cell, the system will verify the SA-signed data service certificates with SA certificate. If the verification fails, you will get the following prompt: **“SSE 06 - SA-signed data service certificates are invalid. Perhaps SA has published a new public key, or the electronic charts are from other service providers.”** Click “Yes”, and the installation is suspended.

3. Verify Documents of Electronic Chart Cells

The system verifies documents of electronic chart cells with SA-signed data service certificates:

1) If electronic charts are signed in a wrong format, you will get the following prompt: **“SSE 24 - the electronic charts are signed in a wrong way. Please contact your data service provider.”** Click “Yes”, and the installation is suspended.

2) If the verification fails, you will get the following prompt: **“The signature of SSE 09 - [CN303317] electronic chart is invalid, so please verify its source.”** Click “Yes”, and the installation is suspended.

4. Check the availability of cell permit

The system checks if the cell permit corresponding to an electronic cell permit has been installed. If pertinent cell permit hasn't been installed, you will get the following prompt: **“SSE 11 - the cell permit of [CN303317] electronic chart isn't found. Please install the cell permit document from your data service provider (PERMIT.TXT).”** If you click

“Yes”, this electronic chart cell will be ignored by the system to install the next electronic chart cell.

5. Check if a cell permit has expired

If the cell permit has been installed for corresponding electronic chart cell, the system will check the update date of the chart cell and expiry date of the cell permit. Besides, it will confirm if the expiry date of the cell permit is later than the update date. If the cell permit has expired, you will get the following prompt: **“SSE 15 - the license of [CN302307] electronic chart has expired. Please contact your data service provider to renew the license of electronic charts.”** If you click “Yes”, the electronic chart cell will be still installed on the system, but following warning will be given if the electronic chart of any expired cell permit is displayed later: **“SSE 25 - the license of [CN302307] electronic charts has expired. Please don’t use it for navigation.”**

6. Check if the cell permit will remain valid for less than 30 days or not

If the cell permit of an electronic chart cell will remain valid for less than 30 days, you will get the following prompt: **“SSE 20 - the license of the electronic chart will remain valid for less than 30 days. Please promptly contact your data service provider to renew the license of the electronic chart.”** If you click “Yes”, you will decrypt and install the electronic chart cell.

7. Decrypt and install an electronic chart cell

The system installs an electronic chart cell with corresponding cell permit. If the electronic chart cell can’t be decrypted, you will get the following prompt: **“SSE 21 - the decryption of the [CN302307] electronic chart fails, and the cell permit is invalid. The cell permit possibly belongs to other equipment, or the cell permit has been updated. Please contact your data service provider to get a new one.”** Once you click “Yes”, the system will ignore this electronic chart cell and install the next one.

- After all electronic chart cells inside a data packet of electronic charts are installed, if multiple volumes are included in that data packet, a file dialog will pop up in the system to instruct you to choose the position of root directory for the next volume and continue installing electronic charts until all volumes are installed.

Time	Cell name	Status	Edition number	Update number	Type	Anomalies
2016-07-26 14:36:02	GB4X0000.000	application	2	0	automatic	
2016-07-26 14:36:02	GB5X01NE.000	application	1	0	automatic	
2016-07-26 14:36:02	GB5X01NW...	application	2	0	automatic	
2016-07-26 14:36:02	GB5X01SE.000	application	1	0	automatic	
2016-07-26 14:36:02	GB5X01SW.0...	application	1	0	automatic	
2016-07-26 14:36:02	GB5X02SE.000	application	1	0	automatic	
2016-07-26 14:36:13	GB4X0000.000	rejection	2	0	automatic	Cells/updates already installed
2016-07-26 14:36:13	GB5X01NE.000	rejection	1	0	automatic	Cells/updates already installed

- After the installation, documents named **PRODUCT.TXT** will be included in the data packet of electronic charts, and the product directory will be simultaneously updated.
- The updated product catalogue possibly exists in the canceled electronic chart cell. For each electronic chart cell that has been canceled, you will get the following prompt: “[CN302307] electronic chart cell has been canceled or won’t be updated any longer. In no case shall it be used for navigation. Are you sure to uninstall this electronic chart cell?” Once you click “Yes”, the system will uninstall this electronic chart cell. You can also click “No” to retain the electronic chart cell. However, you will still receive this prompt when you browse this electronic chart cell in the future.

3.9.2 Install Map (S-57 Electronic Chart)

Some data packets of S-57 electronic charts are possibly not organized according to S-63 data protection solution, so ways of manual installation shall be provided. Notes: the manual installation doesn’t support data of S-63 electronic charts.

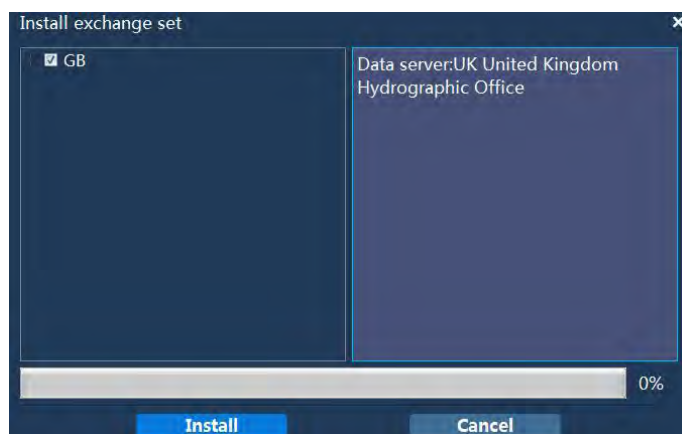

Click “install map” to enter the window of “choose file” to select the address to load documents, find the file “ENC_ROOT” to be loaded, select the file named “ENC_ROOT” and click “choose file”.

3.10 Uninstall electronic chart

You can uninstall an electronic chart in the dialog box of the chart cell. After the electronic chart is uninstalled, it will be deleted from the record of the cell record. Then, it won’t be used for display and navigation any more.

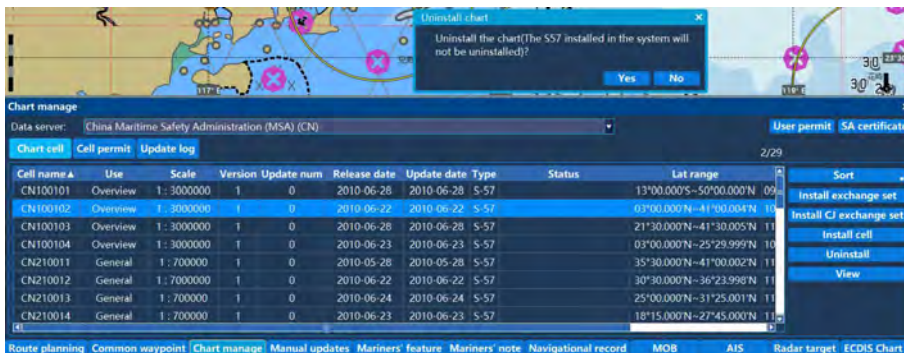

- As you click “uninstall”, a tooltip will pop up. If you click “Yes”, the chart will be uninstalled. Once you click “No”, the chart will not be uninstalled.

3.11 Update log



Your previous records of installing, updating and uninstalling electronic chart units are saved by update log of electronic chart cells. Each log shall cover following information:

Cell Name	e.g. CN302307
Version No.	The update can't be applied unless its Version No. is consistent with that of the installed electronic chart cell, or else it will be rejected.
Update No.	The update can't be applied unless its Update No. Is consistent with that of the installed electronic chart cell, or else it will be rejected.
Date of Issue	The date of issue of basic documents or updated ones.
Time of Application	Time and date of installing basic documents or updated ones for an electronic chart cell.
State	Options include application/reject/lack/uninstall
Details	For rejected electronic chart cells, reasons will be hereby explained (please refer to the descriptions about “Version No.” and “Update No” in the form) For canceled electronic chart cells, names of their substitutes will be hereby listed, such as FR312345 and FR323456 .

The update records are kept within the system until corresponding electronic charts are replaced by the new versions.

Chapter 4

Equipment maintenance

This chapter describes the maintenance and fault diagnosis equipment.



4.1 Equipment maintenance

Equipment can be easily replaced, the board does not need to repair fine recalibration or readjustment.

Split device to monitor and control the host, display problems when replacement monitor, the new monitor is connected to the control panel can work without any recalibration or readjustment; need to confirm resolution of the display. The 19-inch display resolution should be set to 1280 * 1024, the 24-inch monitor resolution should be set to 1920 * 1080.

Control panel problems arise after the replacement control panel, new control panels connect the monitor can work, it does not require any recalibration or readjustment.

(1) Black screen

When users find that display a black screen with no signal input. The need to connect the monitor cable to the control on another host, if the display still does not show this time, it is determined that the display problem and needs to replace the monitor. There are displays on the screen if it is connected to another one of the control panel, the control panel is determined that the problem, need to replace the control panel, and contact the manufacturer.

(2) White screen

When you find the display black and white, there is no signal input. The need to connect the monitor cable to the control on another host, if the display still does not show this time, it is determined that the display problem and needs to replace the monitor. There are displays on the screen if it is connected to another one of the control panel, the control panel is determined that the problem, need to replace the control panel, and contact the manufacturer.

(3) Blue screen

When users find a blue screen monitor, there is no signal input. The need to connect the monitor cable to the control on another host, if the display still does not show this time, it is determined that the display problem and needs to replace the monitor. There are displays on the screen if it is connected to another one of the control panel, the control panel is determined that the problem, need to replace the control panel, and contact the manufacturer.

(4) Display screen freeze (crash)

When you find the display screen freezes, freezes the situation. First restart the device, whether the system will normally enter the chart interface. If the system can normally enter the chart interface, also can be used normally, then contact the manufacturer, the upgrade procedures. If the system can't normally enter the chart interface, you need to contact the manufacturer to download the package again to update the system.

(5) Display screen-printing characters row (crash)

When you find the display screen-printing characters row (background is white or blue or black), panic situation. First restart the device, whether the system will normally enter the chart interface. If the system can normally enter the chart interface, also can be used normally, then contact the manufacturer, the upgrade procedures. If the system can't normally enter the chart interface, you need to contact the manufacturer to download the package again to update the system.

4.2 Operation Manual for HM-5818 Update Disk

The following steps would be for updating ECDIS application. Before you're ready to update it, please make sure that you have the *USB flash disk with latest Update Package*. And then follow the steps one by one.

4.2.1 Select boot device (If the default boot device is USB flash disk, you can skip this step)

- Insert **USB Flash Disk With Latest Update Package**, turn on the ECDIS and keep pressing **F7** key on the keyboard and don't stop until you can see the menu of boot device as the following picture. Select the USB Flash disk (For example, TOSHIBA TransMemory 1.00), and then press **Enter** key to enter the function menu.

Table 1 Description of options

P0: SATA SSD	Built-in SSD
TOSHIBA TransMemory 1.00	USB flash disk The name here may be different from the USB flash disk you actually use. You can confirm which one is your USB by excluding the other two choices.
Enter Setup	Enter the BIOS Setup

[Please remove the live-medium, close the tray (if any) and press ENTER to continue:]

At this time, you can remove your USB flash disk, and then press ENTER key.

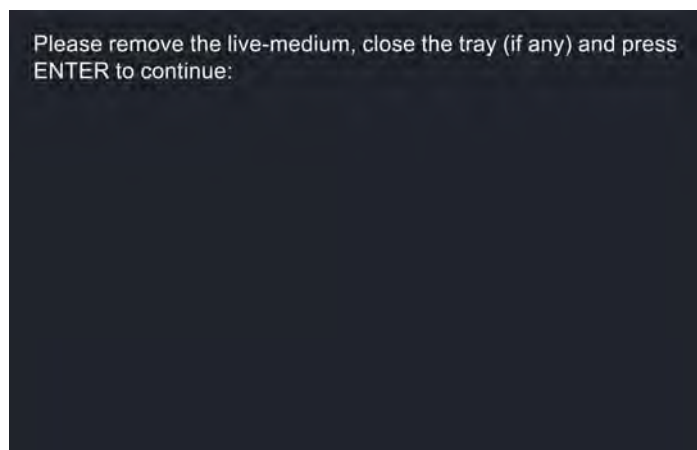

4.3 Operation manual for HM-5818 system rescue

The following steps would be for recovering ECDIS application & OS. You can follow the steps to do recovery when ECDIS was broken down or couldn't boot up any more. These steps should be performed carefully with System Rescue Disk.

4.3.1 Select boot device

- Insert **System Rescue disk**, turn on the ECDIS and keep pressing **F7** key on the keyboard and don't stop until you can see the menu of boot device as the following picture. Select the USB flash disk (For example, TOSHIBA TransMemory 1.00), and then press **Enter** key to enter the function menu.

Chart 1 Description of options

P0: SATA SSD	Built-in SSD
TOSHIBA TransMemory 1.00	USB flash disk The name here may be different from the USB flash disk you actually use. You can confirm which one is your USB by excluding the other two choices.
Enter Setup	Enter the BIOS Setup

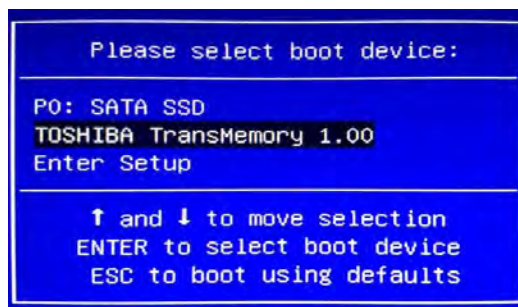

4.3.2 Function Options

- After selected the USB flash disk, it would enter the menu of **System Rescue**:

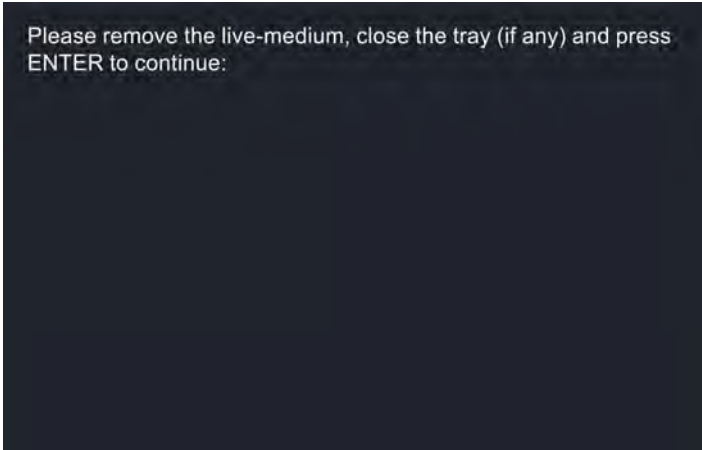

Table 2 Description of options

No.	options	Description
1	General Recovery	Recover application & OS.
2	Advanced Options [Professional User]	Warning: Advanced Options might make user data and installed ENC-charts lost.

- Select **Advanced Options[Professional User]**, press **Enter** key and then it would enter the advanced options :





Please remove the live-medium, close the tray (if any) and press ENTER to continue:

4.3.4 Advanced Options

- In some cases, after the recovery finished, ECDIS is still unavailable or not worked, it might be caused by broken data. If you retried **General Recovery** and failed again, you can try **Advanced Options**, such as Clear User Data, Clear Electrical Nautical Charts, Factory Recovery. Since these options would be cleared some data, so if you want to perform these steps, please be careful and referred to **Table 3 Description of advanced options**.

Annex 1: Installation Dimension

Installation Dimension of Host

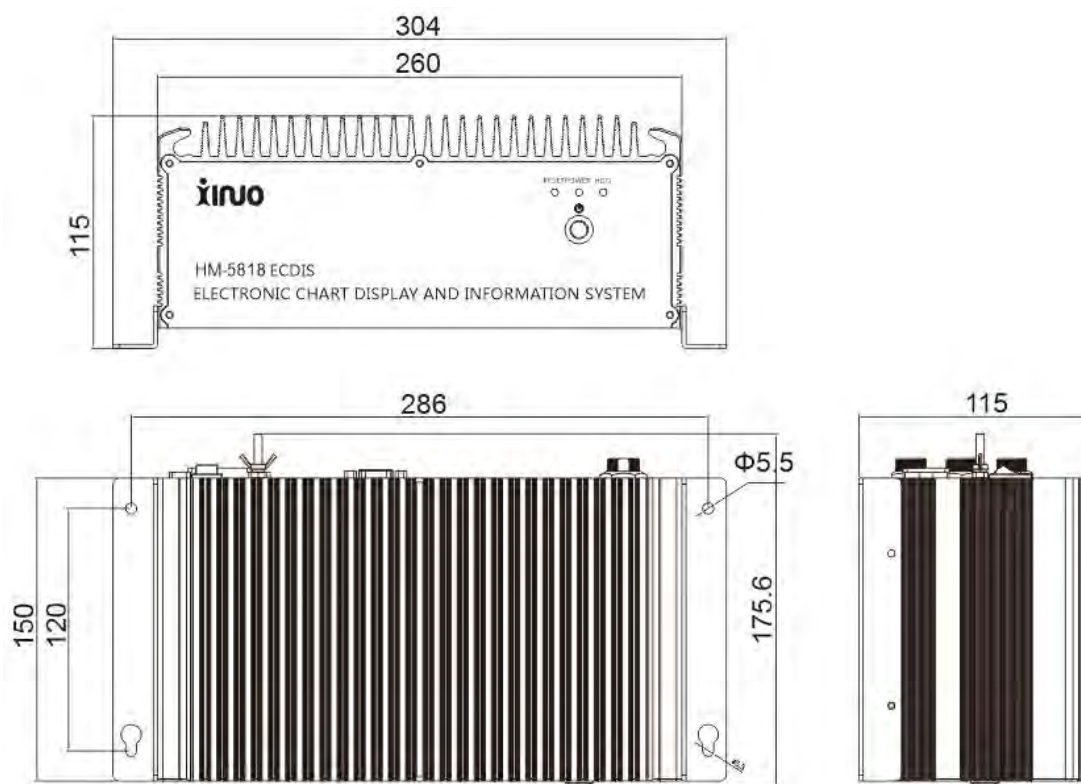

Installation Dimension of Keyboard--trackball

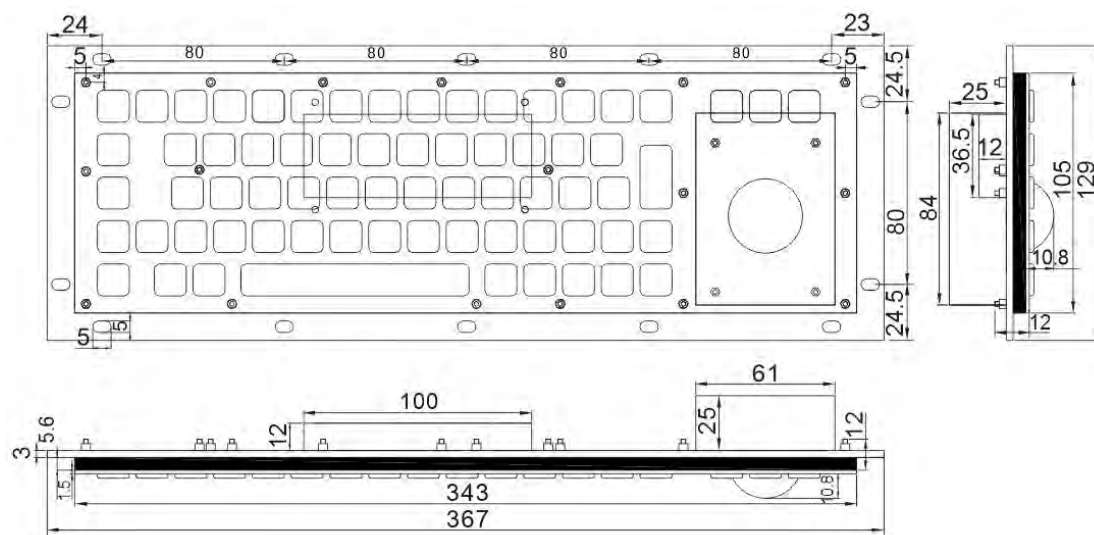

Display Installation of HM-5818(19")

Counter Mounting

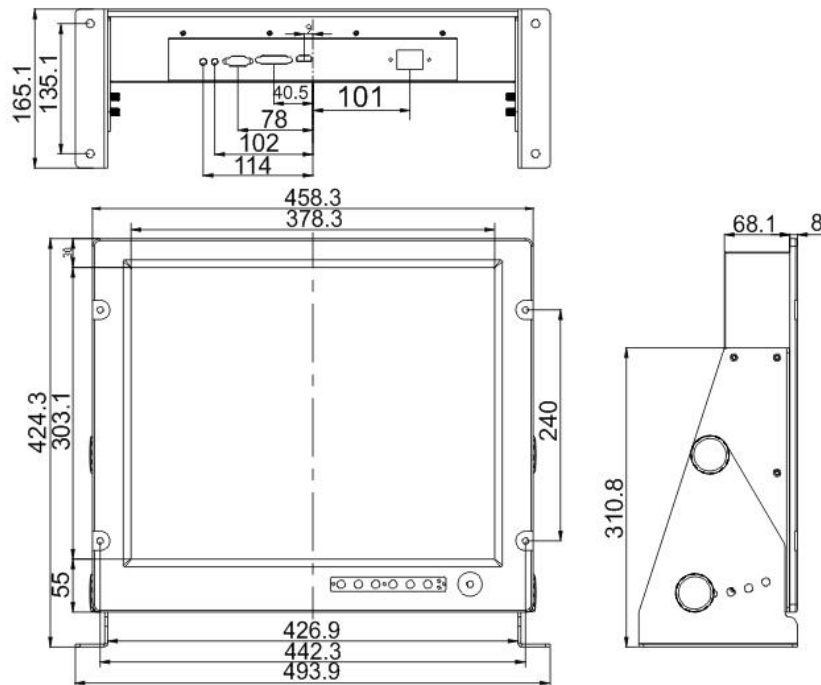

Flush Mounting

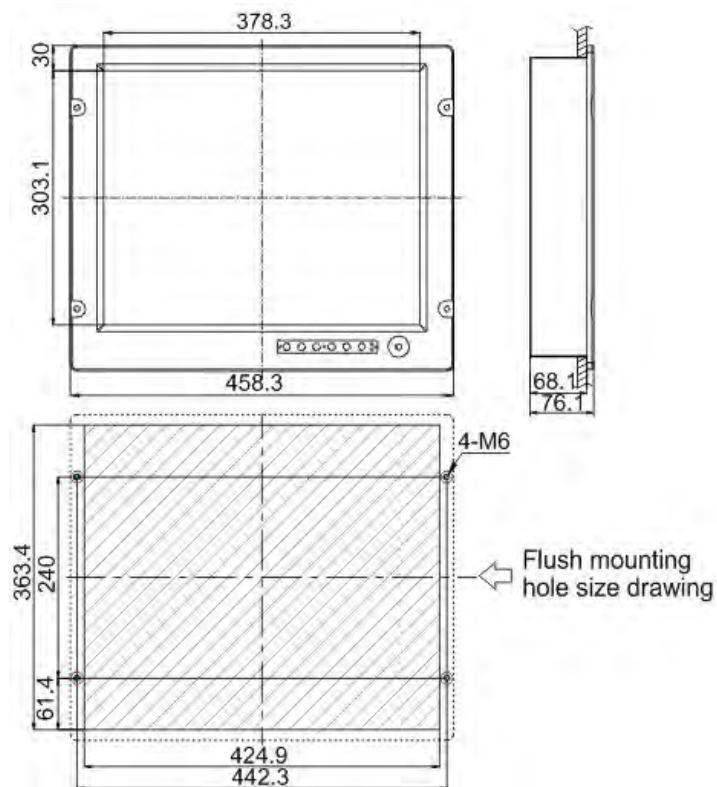

Display Installation of HM-5818(24")

Counter Mounting

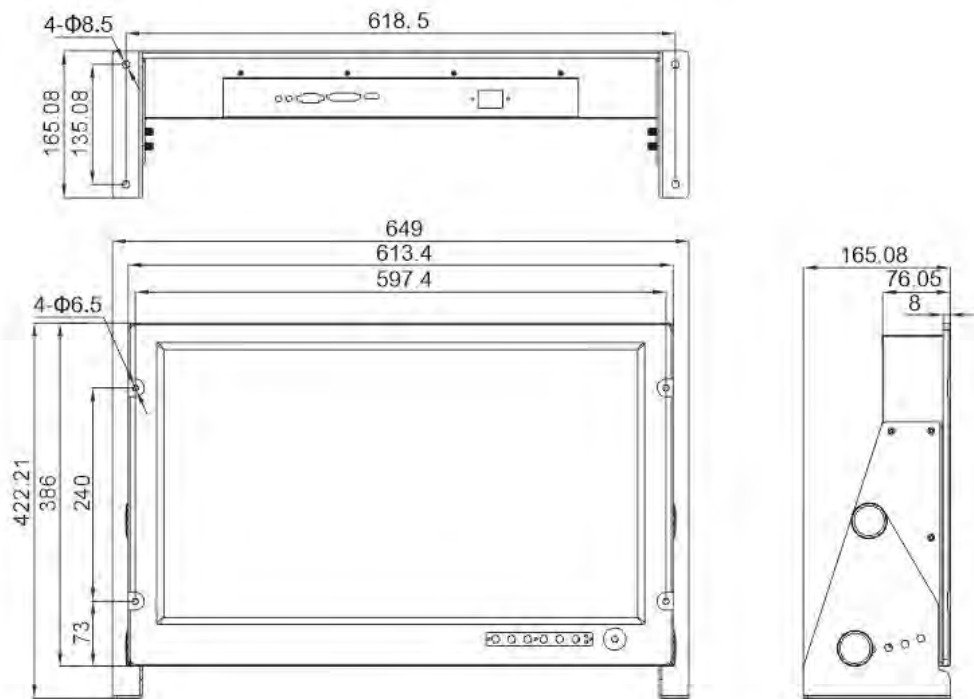

Flush Mounting

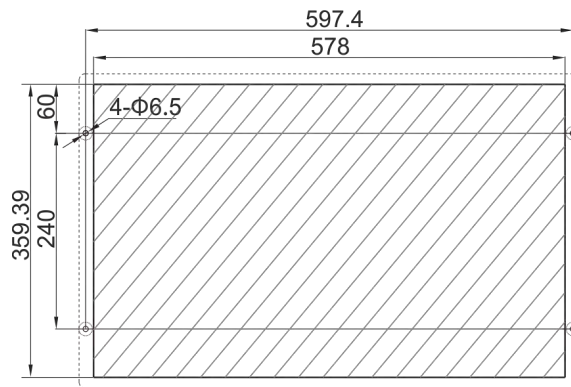

↑
Flush mounting hole size drawing

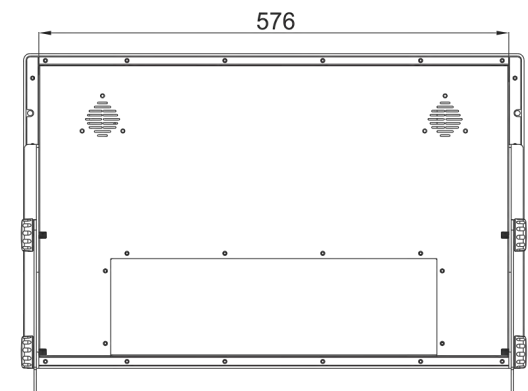

Display Installation of HM-5818(26")

Counter Mounting

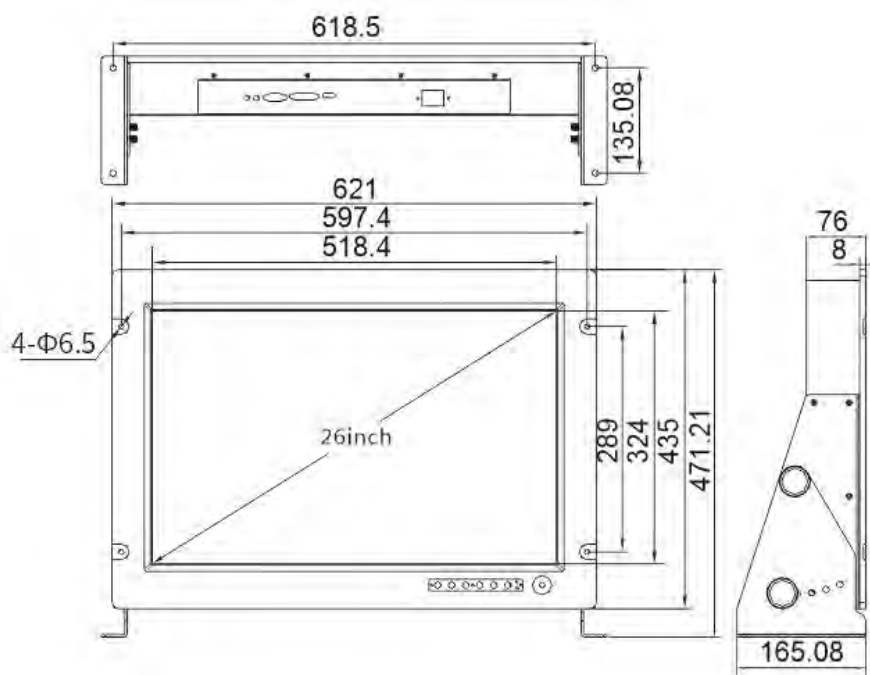

Flush Mounting

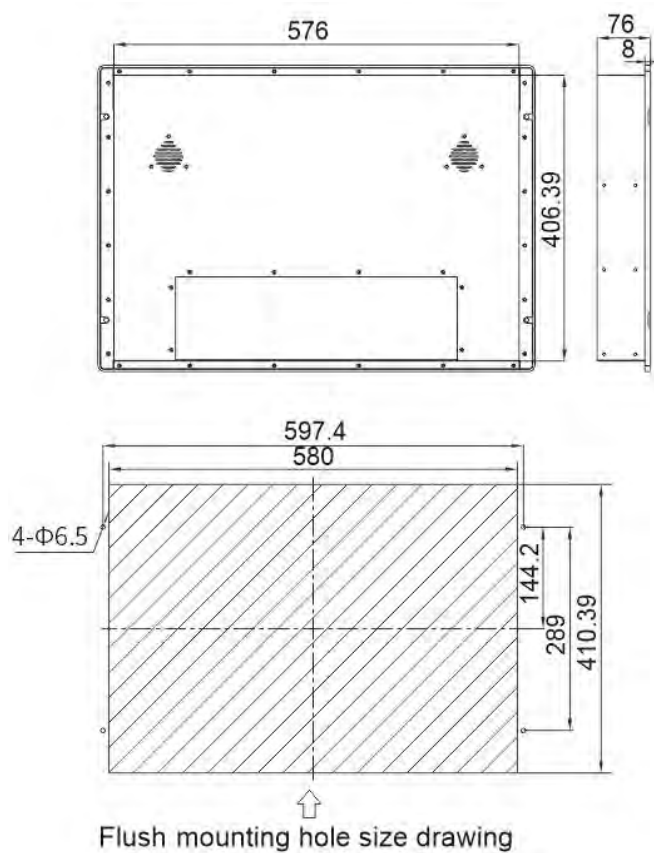

Annex 2: Specifications and Standards

Specifications	IEC 60945	Maritime Navigation and Radio-communication Equipment and Systems - General Requirements - Methods of Testing and Required Test Results, ed4.0, 2002
	IEC 61162-1	Maritime Navigation and Radio-communication Equipment and Systems - Digital Interface - Part 1: Single-transmitter and Multiple-receiver, ed4.0, 2010
	IEC 61162-2	Maritime Navigation and Radio-communication Equipment and Systems - Digital Interface - Part 2: High-speed Single-transmitter and Multiple-receiver, ed1.0, 1998.
	IEC 62288	Maritime Navigation and Radio-communication Equipment and Systems - Presentation of Navigation-related Information Displayed by Vessel borne Navigational System - General Requirements - Test Methods and Required Test Results, ed2.0, 2014.
	IMO A.694(17)	General Requirements for Electronic Navigation Equipment and Vessel borne Radio-communication Equipment Composed by GMDSS
	IMO MSC.232(82)	Performance Standards for Revised Electronic Chart Display and Information System (ECDIS)
	IHO S-52	Specifications for Chart and Display of Electronic Chart Display and Information System (ECDIS), ed6.0, 2010
	IHO S-52, Annex 2	ECDIS Presentation Library, ed3.4, 2008
	IHO S-57	IHO Transfer Standard for Digital Hydrographic Data, ed3.1, 2000
	IHO S-63	IHO Data Protection Solution, ed1.2.0, 2015
	IHO S-64	ECDIS Test Data Set, ed2.0.0, 2012
	CCS GD 22_2015	Guidelines for Type Approval Test of Electric and Electronic Products
	CCS GDXXX_2012	Test Guideline for ECDIS
No. 266 Circular Memorandum of the IMO Maritime Safety Committee	about Display of Electronic Charts and Software Maintenance of Information System	

Annex 3:HM-5818 Specification

Parameter Configuration		
Operation System	Linux	
Software Language	English, Chinese	
Electronic Nautical Chart	IHO S-57 Ed 3.1 Vector Chart (Support IHO S-63 Data Protection Scheme). It support the official S-57 / S-63 electronic chart which is distributed by the UK hydrographic office (UKHO), the China's maritime bureau and so on. And it also support the Yangtze river hydrographic electronic navigation chart database.	
Chart Update	semi-automatic	Install Base/Update S-57/S-63 ENC packages from USB.
	Manual-update	Add/Modify/Delete objects on the SENCs. Manual updates can be distinguished from automatic updates on the screen on
	log	Auto-update and manual-update history records are convenient for retrospecting the historical changes of electronic charts.
Object Information	Select objects on the charts with cursor, and query informations associated (Texts, pictures, and symbol explanations).	
ECIDS Chart 1	The system provides a demonstration chart for new users to learn and familiarize themselves with the S-57 electronic chart and corresponding symbols.	
Planed Route	Rhumb line/Greate circle line, generates wheel-over-line according to configuration.	
Route Detection	Detects the following objects which specific planned route crosses, Navigational hazards. Areas for which special conditions exist. Safety contours. Any object of above deteted will be highlighted to mariners.	
Route Monitoring	Route monitoring detects the following conditions for own ship, Cross track error. Navigational hazards. Areas for which special conditions exist. Safety contours. Indication or warning will be given to mariners if any condition of above happens.	
ECIDS Chart 1	The system provides a demonstration chart for new users to learn and familiarize themselves with the S-57 electronic chart and corresponding symbols.	
Color Palette	Day/Dusk/Night	
Display Mode	3 display categories are predefined-Base/Standard/Other. Each category can be customized by mariners to show or suppress some informations of chart.	

Text Display Setting	Provides switch options like import text, light description, Seabed nature, place name etc. Allows mariner to show or suppress some texts of chart.
User's Note	Information (i) or warning(!) label could be marked at specific position.
User's Object	Mariners' concerned point/line/area could be drawn on the chart.
MOB	When emergency(like MOB) happening, MOB button on the screen can be clicked to record the position of own ship.
Own Ship Positioning	Support primary/secondary position source. Last valid position or LOP can be used as start position for dead rocking.
Voyage Record	Voyage records for last 3 months (position, time, course, speed). Records for last 12 hours are detailed, includes information of referenced ENCS.
Alarm	Alarm or warning for route monitoring, sensor failure, ENC, CPA etc. will be given according to configured priority. Mariners can view and confirm alarms which they received.
Measure Tool	EBUEBRL/VRM
AIS Target	• AIS target query and monitoring.
	• Condition setting (CLASS A/B, range, CPA) for activated or sleeping AIS targets to filter unconcerned ones.
	• Past track for AIS target.
	• CPA/TCPA alarm.
Sensor	Support NMEA0813 input device like GPS, AIS, echo sounder, gyro, log and so on.
Display Unit	
Model	HM-5818(19")
Display Resolution	1280 × 1024 (SXGA)
Aspect Ratio	4:3
Screen Brightness	450cd/m ²
Screen Size	376mm × 301mm
Viewing Angle	Horizontal, 150° Vertical, 140°
Contrast Ratio	800:1
Model	HM-5818(24")
Display Resolution	1920 × 1080 (WUXGA)

Aspect Ratio	16:9
Screen Brightness	1000cd/m ²
Screen Size	531mm×299mm
Viewing Angle	Horizontal, 170° Vertical, 160°
Contrast Ratio	1000:1
Model	HM-5818(26")
Display Resolution	1920×1200
Aspect Ratio	16:10
Screen Brightness	600cd/m ²
Screen Size	518mm×324mm
Viewing Angle	Horizontal, 178° Vertical, 178°
Contrast Ratio	1000:1
Processor	
CPU	Intel Haswell/Broadwell U series 15W
Memory	DDR3-1066 MT/S 4GB
SSD	SSD 480G
Audio	Audio ALC 662 HD Around a track+the microphone
I/O	6 PIN
Ethernet	1000Mbps
Power	AC 220V & AC 110V
Power Consumption	17W or less (220 VDC)
Compass Input Port	Support
Log Device Input Port	Support
GNSS Port	Support 2 ports,
ARPA Input Port from Radar	Support
AIS Input Port	Support
Video Output Port	VGA,HDMI
USB	4 ports, USB 2.0 type A
LAN Port	LAN1, LAN2
Wi-Fi	802.11b/g/n
4G Module	LTE/GSM, Internal antenna, and support to connect external antenna.
keyboard performance	
Keyboard(trackball)	Size, 343mm x 105mm, IP65 Static waterproof dustproof

	explosion-proof, Stainless steel metal industrial keyboard, built-in industrial-grade IMG PCB, embedded instalation.
Environmental	
Operation Temperature	-15° C~+55° C
Storage Temperature	-20° C~+70° C
Language Switch	English, Chinese
Manual	English, Chinese
User Operation	Menu operation/double click/zoom by roller
Workstation	Split device



Xinuo Information Technology (Xiamen) Corporation Limited

Address: Unit 2001, 1 Chengyi North Street (B04), Software Park III, Xiamen, China

Tel: +86-592-3300300 Fax: +86-592-3300310 Hotline: 400-8868-592

Web: <http://www.xinuo.com> Email: info@xinuo.com

